

Overview

The KEMET A798 Aluminum Organic Capacitor (AO-CAP) is a solid state aluminum capacitor. The cathode is a conductive organic polymer, which results in very low ESR and improved capacitance retention at high frequency. AO-CAPs may be operated at steady state voltages up to 100% of rated voltage without the need to de-rate.

Since there is no liquid electrolyte, the A798 offers long operational lifetimes, low ESR, and high operational temperatures. The inherent low ESR renders the A798 suitable for high ripple current handling. The small

package size, high ripple current capability, high operating temperature, low parasitics, and capacitance stability over life span makes the A798 ideal for demand applications.

The A798 High Humidity and High Temperature Aluminium Polymer capacitors deliver higher capacitance and ESR stability under harsh environmental conditions. Enhancements to the design and selected material upgrades were introduced to deliver 1,000 hours at 85°C/85% RH rated voltage and 125°C Endurance Life and Storage.

Benefits

- Minimum ESR up to 3 mΩ
- Polymer cathode technology
- Extended plus performance grade with extended life up to 5,500 hours at 125°C
- High frequency capacitance retention
- 100% accelerated steady state aging
- 100% surge current tested
- Volumetric efficiency
- Self-healing mechanism
- EIA standard case sizes

Applications

Typical applications include DC/DC converters, notebook PCs, telecommunications, displays, and industrial applications with harsh humidity and temperature requirements..

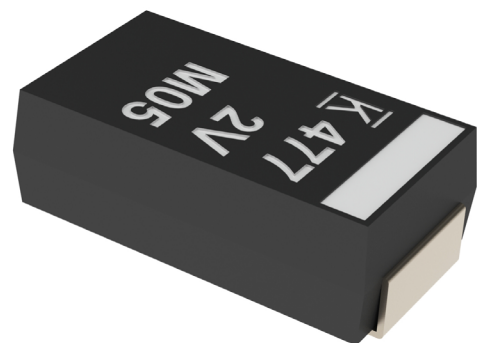
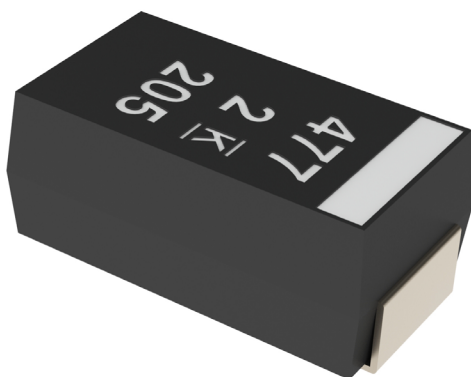

Aluminum Organic Capacitor (AO-CAP)

A798 High Humidity and High Temperature Polymer Aluminum

Environmental Compliance

RoHS compliant when ordered with 100% Sn or Ni-Pd-Au.

- Halogen-free
- Epoxy compliant with UL94 V-0

K-SIM

For a detailed analysis of specific part numbers, please visit ksim.kemet.com to access KEMET's K-SIM software. KEMET K-SIM is designed to simulate behavior of components with respect to frequency, ambient temperature, and DC bias levels.

Ordering Information

A	798	D	477	M	002	A	T	E009	
Capacitor Class	Series	Case Size	Capacitance Code (pF)	Capacitance Tolerance	Rated Voltage (VDC)	Failure Rate/Design	Termination Finish	ESR	Packaging (C-Spec)
A = Aluminum	798 = High Humidity/ High Temperature Aluminum Polymer	D V	First two digits represent significant figures. Third digit specifies number of zeros.	M = ±20%	002 = 2 2R5 = 2.5	A = N/A	T = 100% Matte Tin (Sn)-plated P = Ni-Pd-Au	E = ESR Last three digits specify ESR in mΩ (009 = 9 mΩ)	Blank = 7" Reel 7280 = 13" Reel

A798 Plus Performance

A	798	D	477	M	002	P	T	E009	
Capacitor Class	Series	Case Size	Capacitance Code (pF)	Capacitance Tolerance	Rated Voltage (VDC)	Failure Rate/Design	Termination Finish	ESR	Packaging (C-Spec)
A = Aluminum	798 = High Humidity/ High Temperature Aluminum Polymer	D V	First two digits represent significant figures. Third digit specifies number of zeros.	M = ±20%	002 = 2 2R5 = 2.5 004 = 4 006 = 6.3	P = Plus Performance (Extended Life 3,000 hours/125°C)	T = 100% Matte Tin (Sn)-plated P = Ni-Pd-Au	E = ESR Last three digits specify ESR in mΩ (009 = 9 mΩ)	Blank = 7" Reel 7280 = 13" Reel

Aluminum Organic Capacitor (AO-CAP)

A798 High Humidity and High Temperature Polymer Aluminum

Ordering Information cont.

A798 Extended Plus Performance

A	798	V	477	M	002	R	T	E009	
Capacitor Class	Series	Case Size	Capacitance Code (pF)	Capacitance Tolerance	Rated Voltage (VDC)	Failure Rate/Design	Termination Finish	ESR	Packaging (C-Spec)
A = Aluminum	798 = High Humidity/ High Temperature Aluminum Polymer	V	First two digits represent significant figures. Third digit specifies number of zeros.	M = ±20%	002 = 2 2R5 = 2.5	R = Extended Plus Performance (Extended Life 5,500 hours/125°C)	T = 100% Matte Tin (Sn)-plated	E = ESR Last three digits specify ESR in mΩ (009 = 9 mΩ)	Blank = 7" Reel

Performance Characteristics

Item	Performance Characteristics
Operating Temperature	-55°C to 125°C
Rated Capacitance Range	150 - 560 µF at 120 Hz/25°C
Capacitance Tolerance	M Tolerance (20%)
Rated Voltage Range	2 – 6.3 V
DF (120 Hz)	6%
ESR (100 kHz)	Refer to Part Number Electrical Specification Table
Leakage Current	<p>≤ 2.5 V Rating: ≤ 0.1 CV (µA) at rated voltage after 5 minutes</p> <p>If there is any concern about leakage current, please perform pre-conditioning to the part following below conditions:</p> <ul style="list-style-type: none"> * Temperature: 105°C maximum * Voltage: Rated Voltage * Series Resistor: 1,000 Ω * Charge Time: 1 hour minimum * Measuring: Discharge the capacitor(s), store them for 4 to 24 hours at room temperature and RH ≤ 60%

Aluminum Organic Capacitor (AO-CAP)

A798 High Humidity and High Temperature Polymer Aluminum

Qualification

Test	Condition	Characteristics				
Endurance	125°C at rated voltage, 1,000 hours *3	Δ C/C	Within ±20% *4 of initial value			
		DF	≤ initial limit			
		DCL	Within 1.25 x initial limit			
		ESR	Within 2.0 x initial limit			
Storage Life	125°C at 0 Volts, 1,000 hours	Δ C/C	Within ±20% of initial value			
		DF	Within initial limits			
		DCL	Within 1.25 x initial limit			
		ESR	Within 2.0 x initial limit			
Endurance Extended	A798 Plus Performance Temperature: 125°C Voltage: 1.0 Rated Voltage 0.8 Rated Voltage (for parts with derate category 2) Time: 3,000 or 5500 hours*5	Δ C/C	Within ±30% of initial value			
		DF	≤ initial limit			
		DCL	Within 1.25 x initial limit			
		ESR	Within 2.0 x *2 initial limit			
Storage Life Extended	A798 Plus Performance 125°C at 0 Volts, 3,000 hours or 5500 hours*5	Δ C/C	Within ±30% of initial value			
		DF	≤ initial limit			
		DCL	Within 1.25 x initial limit			
		ESR	Within 2.0 x *2 initial limit			
Humidity	85°C, 85% RH, load, 1,000 hours	Δ C/C	Within -20/+70% of initial value			
		DF	Within 2.0 x initial limit			
		DCL	Within 5.0 x initial limit			
		ESR	Within 2.0 x initial limit*6			
Temperature Stability	Extreme temperature exposure at a succession of continuous steps at -55°C, +25°C, +85°C, +125°C	Δ C/C	+25°C	-55°C	+85°C	+125°C
		DF	IL*1	±15%	±15%	±20%
		DCL	IL	IL	1.2 x IL	1.5 x IL
Surge Voltage	125°C, 1.32 x rated voltage, 33 Ω resistance, 1,000 cycles	Δ C/C	Within ±20% of initial value			
		DF	Within initial limits			
		DCL	Within initial limits			
		ESR	Within initial limits			
Mechanical Shock/ Vibration	MIL-STD-202, Method 213, Condition I, 100 G peak MIL-STD-202, Method 204, Condition D, 10 Hz to 2,000 Hz, 20 G peak	Δ C/C	Within ±10% of initial value			
		DF	Within initial limits			
		DCL	Within initial limits			

*1 IL = Initial Limit

*2 For PN's: A798D477M2R5PTE006, A798D477M002PTE006 and PP termination/ E003 the ESR post test is 3.0 x of initial limit

*3 For PN's: A798D477M002ATE006, A798D477M002ATE009, A798D477M2R5ATE006 and A798D477M2R5ATE009 test condition specification goes up to 2,000 hours

*4 For PN's: A798D477M002ATE006, A798D477M002ATE009, A798D477M2R5ATE006 and A798D477M2R5ATE009 capacitance change is within ± 30 of initial value

*5 Extended 5500 hours is applicable for PN with letter R in the 13th digit

*6 For, PN's with letters PP in Failure Rate/Design and Termination Finish positions / E003, the ESR post test is 3.0 x of initial limit

Aluminum Organic Capacitor (AO-CAP)

A798 High Humidity and High Temperature Polymer Aluminum

Electrical Characteristics

ESR vs. Frequency

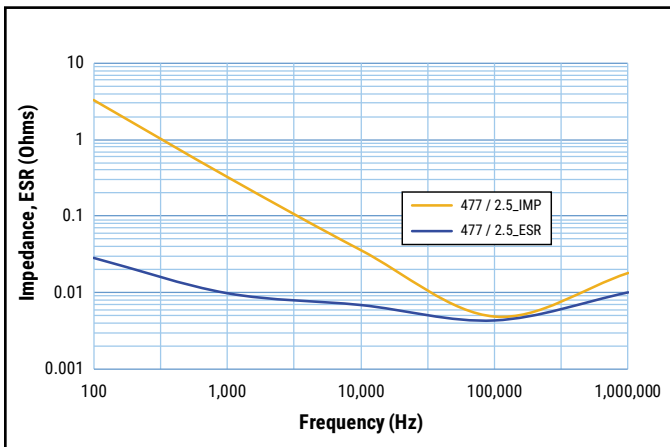

Capacitance vs. Frequency

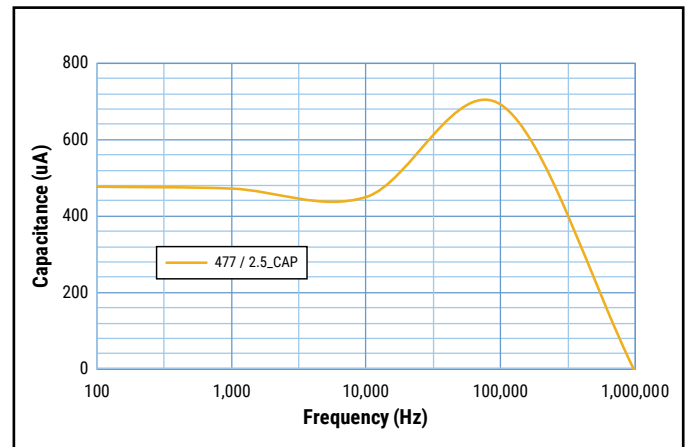

Dimensions – Millimeters (Inches)

Metric will govern

SIDE VIEW

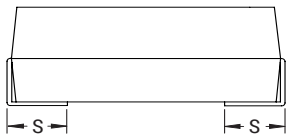

END VIEW

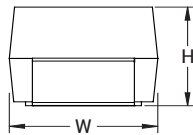

BOTTOM VIEW*

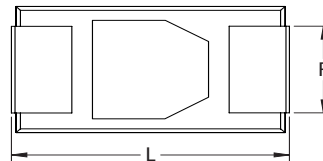

*Glue pad shape is at KEMET's option

Case Size		Component					Typical Weight
KEMET	EIA	L	W	H	F ±0.1 ±(0.004)	S ±0.3 ±(0.012)	(mg)
V	7343-21	7.3±0.3 (0.287±0.012)	4.3±0.3 (0.169±0.012)	1.9±0.2 (0.075±0.008)	2.4 (0.094)	1.3 (0.051)	132.72
D	7343-31	7.3±0.3 (0.287±0.012)	4.3±0.3 (0.169±0.012)	2.8±0.3 (0.110±0.012)	2.4 (0.094)	1.3 (0.051)	196.58

Notes: (Ref) – Dimensions provided for reference only.

Aluminum Organic Capacitor (AO-CAP)

A798 High Humidity and High Temperature Polymer Aluminum

Table 1 – Ratings & Part Number Reference

Rated Voltage	Rated Capacitance	Case Code/ Case Size	KEMET Part Number	DC Leakage	DF	ESR	Maximum Allowable Ripple Current	Maximum Allowable Ripple Current	Maximum Allowable Ripple Current	MSL	Maximum Operating Temp.	Derate
(V) at 125°C	µF	KEMET/EIA		µA at +25°C Maximum/ 5 Minutes	% at +25°C 120 Hz Maximum	mΩ at 25°C 100 kHz Maximum	(mA 85°C 100 kHz)	(mA 105°C 100 kHz)	(mA 125°C 100 kHz)	Reflow Temp ≤ 260°C	°C	Category
125°C / 1000 Hrs endurance												
2	330	V/7343-21	A798V337M002RTE009	66	6	9	6,750	4,725	1,690	3	125	1
2	470	V/7343-21	A798V477M002APE003	56.4	6	3	11,690	8,180	2,920	3	125	1
2	470	V/7343-21	A798V477M002APE4R5	56.4	6	4.5	9,540	6,680	2,390	3	125	1
2	470	V/7343-21	A798V477M002PTE009	56.4	6	9	6,750	4,725	1,690	3	125	1
125°C / 2000 Hrs endurance												
2	470	D/7343-31	A798D477M002ATE006	94	6	6	6,460	4,522	1,615	3	125	1
2	470	D/7343-31	A798D477M002ATE009	94	6	9	5,270	3,690	1,320	3	125	1
2.5	470	D/7343-31	A798D477M2R5ATE006	117.5	6	6	6,460	4,522	1,615	3	125	1
2.5	470	D/7343-31	A798D477M2R5ATE009	117.5	6	9	5,270	3,690	1,320	3	125	1
125°C / 3000 Hrs endurance												
2	470	V/7343-21	A798V477M002PPE003	56.4	6	3	11,690	8,180	2,920	3	125	1
2	470	V/7343-21	A798V477M002PPE4R5	56.4	6	4.5	9,540	6,680	2,390	3	125	1
2	470	V/7343-21	A798V477M002PPE006	56.4	6	6	6,460	4,522	1,615	3	125	1
2	470	V/7343-21	A798V477M002PTE009	56.4	6	9	6,750	4,725	1,690	3	125	1
2	470	D/7343-31	A798D477M002PTE006	56.4	6	6	6,460	4,522	1,615	3	125	1
2	470	D/7343-31	A798D477M002PTE009	56.4	6	9	5,270	3,690	1,320	3	125	1
2	560	V/7343-21	A798V567M002PPE003	67.2	6	3	11,690	8,180	2,920	3	125	1
2	560	V/7343-21	A798V567M002PPE4R5	67.2	6	4.5	9,540	6,680	2,390	3	125	1
2	560	V/7343-21	A798V567M002PPE006	67.2	6	6	6,460	4,522	1,615	3	125	1
2.5	470	V/7343-21	A798V477M2R5PPE003	70.5	6	3	11,690	8,180	2,920	3	125	2
2.5	470	D/7343-31	A798D477M2R5PTE006	70.5	6	6	6,460	4,522	1,615	3	125	1
2.5	470	D/7343-31	A798D477M2R5PTE009	70.5	6	9	5,270	3,690	1,320	3	125	1
2.5	560	V/7343-21	A798V567M2R5PPE003	84	6	3	11,690	8,180	2,920	3	125	2
4	220	V/7343-21	A798V227M004PTE012	88	6	12	5,850	4,090	1,460	3	125	1
4	220	V/7343-21	A798V227M004PTE015	88	6	15	5,230	3,670	1,310	3	125	1
6.3	150	V/7343-21	A798V157M006PTE015	94.5	6	15	5,230	3,670	1,310	3	125	1
6.3	220	V/7343-21	A798V227M006PTE012	138.6	6	12	5,850	4,090	1,460	3	125	1
6.3	220	V/7343-21	A798V227M006PTE015	138.6	6	15	5,230	3,670	1,310	3	125	1
125°C / 5500 Hrs endurance												
2	330	V/7343-21	A798V337M002RTE009	66	6	9	6,750	4,725	1,690	3	125	1
2	470	V/7343-21	A798V477M002RTE009	94	6	9	6,750	4,725	1,690	3	125	1
2.5	330	V/7343-21	A798V337M2R5RTE009	82.5	6	9	6,750	4,725	1,690	3	125	2
Rated Voltage	Rated Capacitance	Case Code/ Case Size	KEMET Part Number	DC Leakage	DF	ESR	Ripple Current (mA 85°C)	Ripple Current (mA 105°C)	Ripple Current (mA 125°C)	MSL	Maximum Operating Temp.	Derate category

Derating Guidelines

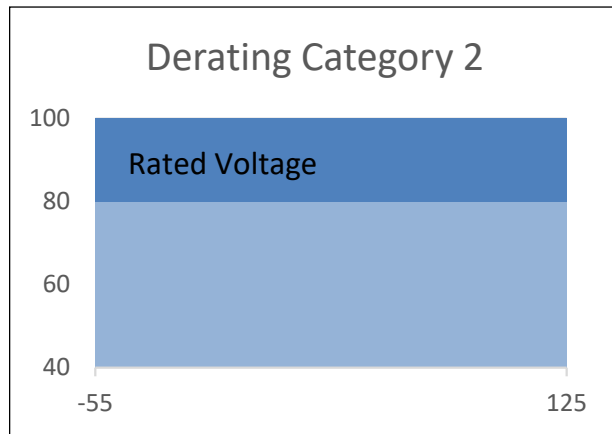
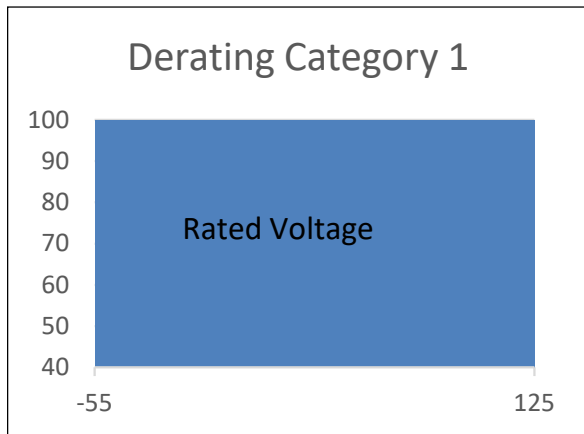

Ripple Current/Ripple Voltage

Permissible AC ripple voltage and current are related to equivalent series resistance (ESR) and the power dissipation capabilities of the device. Permissible AC ripple voltage which may be applied is limited by two criteria

1. The positive peak AC voltage plus the DC bias voltage, if any, must not exceed the DC voltage rating of the capacitor.
2. The negative peak AC voltage, in combination with bias voltage, if any, must not exceed the allowable limits specified for reverse voltage. See the Reverse Voltage section for allowable limits

Power capability is determined based on a 20°C temperature rise. A higher temperature rise and therefore higher power capability is allowable as long as the ambient temperature, plus, temperature rise due to ripple current, does not exceed the rated temperature of the part.

The maximum power dissipation by case size can be determined using the below table.

KEMET Series and Case Code	EIA Case Code	Maximum Power Dissipation (Pmax) mWatts at 25°C with +20°C Rise
D	7343-31	250
V	7343-21	410

Using the Pmax of the device, the maximum allowable rms ripple current or voltage may be determined.

$$I(max) = \sqrt{Pmax/R}$$

$$E(max) = Z \sqrt{Pmax/R}$$

I = rms ripple current (amperes)

E = rms ripple voltage (volts)

Pmax = maximum power dissipation(watts)

R = ESR at specified frequency (ohms)

Z = Impedance at specified frequency (Ohms)

Refer to part number listings for permissible Arms limits.

Temperature Compensation Multipliers for Maximum Ripple Current		
T ≤ 85°C	85°C < T ≤ 105°C	105°C < T ≤ 125°C
1.00	0.70	0.25

T = Environmental Temperature

Aluminum Organic Capacitor (AO-CAP)

A798 High Humidity and High Temperature Polymer Aluminum

Reverse Voltage

Polymer aluminum capacitors are polar devices and may be permanently damaged or destroyed if connected in the wrong polarity. These devices will withstand a certain degree of transient voltage reversal for short periods as shown in the below table. Please note that these parts may not be operated continuously in reverse, even within these limits.

Temperature	Permissible Transient Reverse Voltage
25°C	60% of Rated Voltage
55°C	50% of Rated Voltage
85°C	40% of Rated Voltage
125°C	30% of Rated Voltage

Table 2 – Land Dimensions/Courtyard

KEMET	Metric Size Code	Density Level A: Maximum (Most) Land Protrusion (mm)					Density Level B: Median (Nominal) Land Protrusion (mm)					Density Level C: Minimum (Least) Land Protrusion (mm)						
		Case	EIA	W	L	S	V1	V2	W	L	S	V1	V2	W	L	S	V1	V2
D	7343-31	2.55	2.77	3.67	10.22	5.60	2.43	2.37	3.87	9.12	5.10	2.33	1.99	4.03	8.26	4.84		
V	7343-31	2.55	2.77	3.67	10.22	5.60	2.43	2.37	3.87	9.12	5.10	2.33	1.99	4.03	8.26	4.84		

Density Level A: For low-density product applications. Recommended for wave solder applications and provides a wider process window for reflow solder processes.

Density Level B: For products with a moderate level of component density. Provides a robust solder attachment condition for reflow solder processes.

Density Level C: For high component density product applications. Before adapting the minimum land pattern variations the user should perform qualification testing based on the conditions outlined in IPC standard 7351 (IPC-7351).

¹ Height of these chips may create problems in wave soldering.

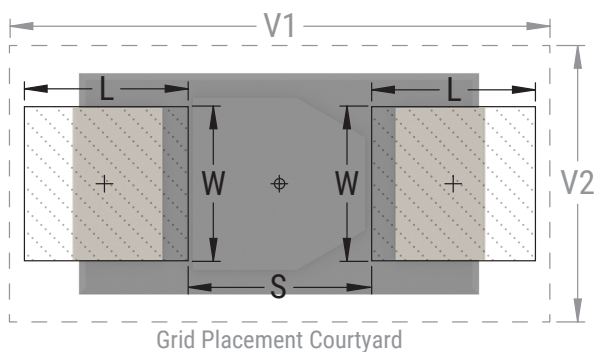

Soldering Process

KEMET’s families of surface mount capacitors are compatible with wave (single or dual), convection, IR, or vapor phase reflow techniques. Preheating of these components is recommended to avoid extreme thermal stress. KEMET’s recommended profile conditions for convection and IR reflow reflect the profile conditions of the IPC/J-STD-020D standard for moisture sensitivity testing. The devices can safely withstand a maximum of three reflow passes at these conditions.

Please note that although the X/7343-43 case size can withstand wave soldering, the tall profile (4.3 mm maximum) dictates care in wave process development.

Hand soldering should be performed with care due to the difficulty in process control. If performed, care should be taken to avoid contact of the soldering iron to the molded case. The iron should be used to heat the solder pad, applying solder between the pad and the termination, until reflow occurs. Once reflow occurs, the iron should be removed immediately. “Wiping” the edges of a chip and heating the top surface is not recommended.

Profile Feature	SnPb Assembly	Pb-Free Assembly
Preheat/Soak		
Temperature Minimum (T_{smin})	100°C	150°C
Temperature Maximum (T_{smax})	150°C	200°C
Time (t_s) from T_{smin} to T_{smax}	60 – 120 seconds	60 – 120 seconds
Ramp-up Rate (T_L to T_p)	3°C/seconds maximum	3°C/seconds maximum
Liquidous Temperature (T_L)	183°C	217°C
Time Above Liquidous (t_L)	60 – 150 seconds	60 – 150 seconds
Peak Temperature (T_p)	220°C* 235°C**	250°C* 260°C**
Time within 5°C of Maximum Peak Temperature (t_p)	20 seconds maximum	30 seconds maximum
Ramp-down Rate (T_p to T_L)	6°C/seconds maximum	6°C/seconds maximum
Time 25°C to Peak Temperature	6 minutes maximum	8 minutes maximum

Note: All temperatures refer to the center of the package, measured on the package body surface that is facing up during assembly reflow.

* For Case Size height > 2.5 mm

** For Case Size height ≤ 2.5 mm

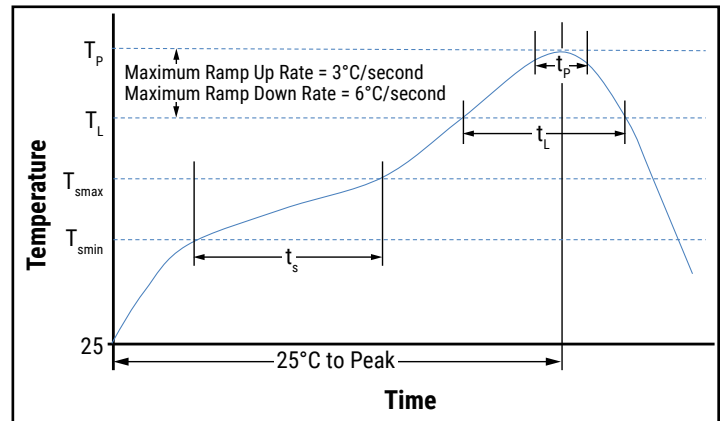

Storage

All AO-CAP Series are shipped in moisture barrier bags (MBBs) with desiccant and humidity indicator card (HIC). These parts are classified as MSL3 (Moisture Sensitivity Level 3) per IPC/JEDEC J-STD-020 and packaged per IPC/JEDEC J-STD-033. MSL3 specifies a floor time of 168H at 30°C maximum temperature and 60% relative humidity. Unused capacitors should be sealed in a MBB with fresh desiccant.

The calculated shelf life in a sealed bag would be 12 months from a bag seal date in a storage environment of < 40°C and humidity < 90% RH. It should be 24 months from a bag seal date in a storage environment of < 30°C and humidity < 70% RH.

If baking is required, refer to IPC/JEDEC J-STD-033 for bake procedure.

Aluminum Organic Capacitor (AO-CAP)

A798 High Humidity and High Temperature Polymer Aluminum

Construction

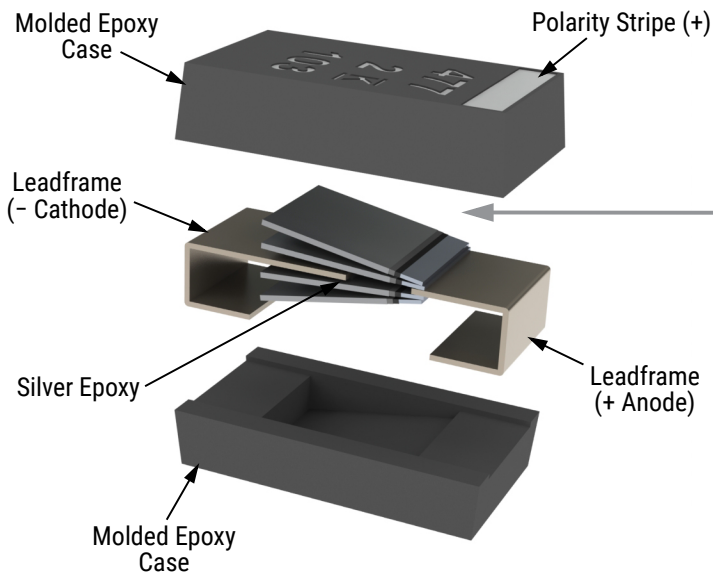

Detailed Element Layer View

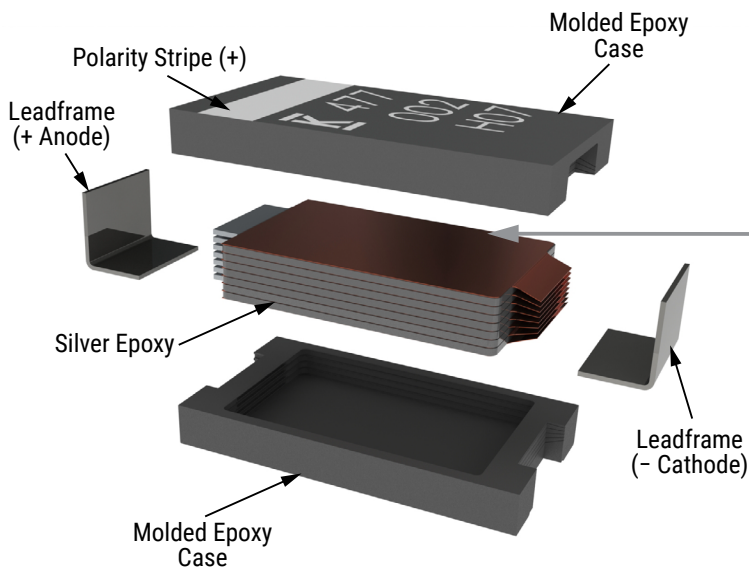
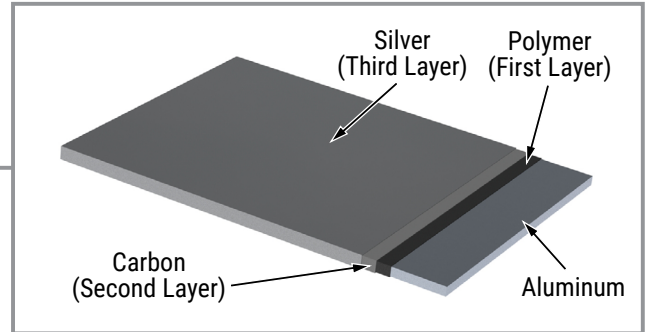

Detailed Element Layer View

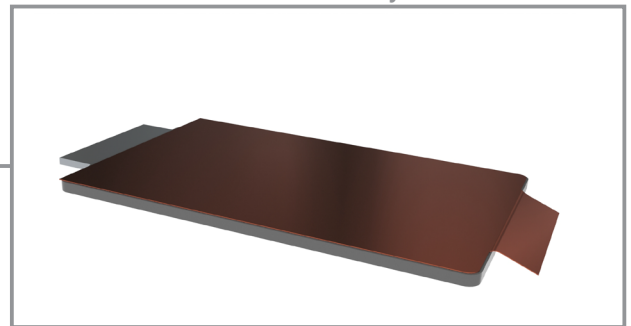

Aluminum Organic Capacitor (AO-CAP)

A798 High Humidity and High Temperature Polymer Aluminum

Capacitor Marking

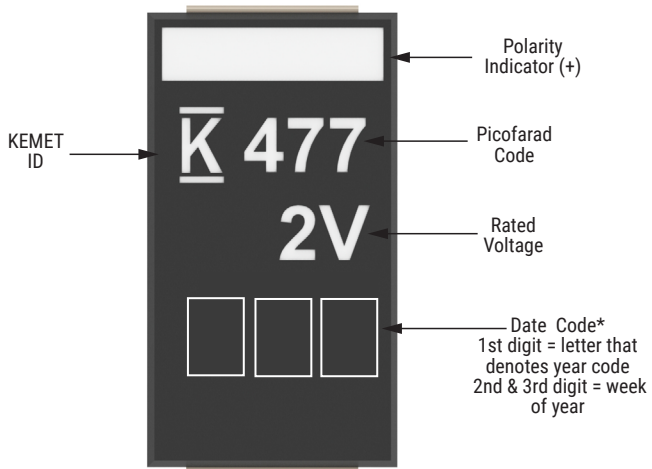
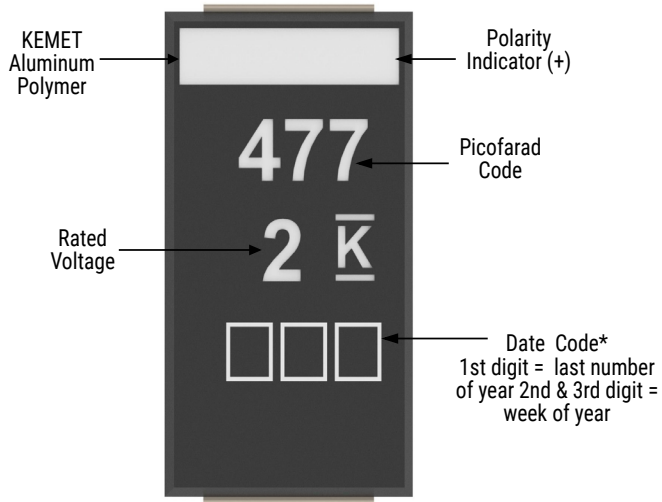

Aluminum Organic Capacitor (AO-CAP)

A798 High Humidity and High Temperature Polymer Aluminum

Tape & Reel Packaging Information

KEMET's molded chip capacitor families are packaged in 8 and 12 mm plastic tape on 7" and 13" reels in accordance with *EIA Standard 481: Embossed Carrier Taping of Surface Mount Components for Automatic Handling*. This packaging system is compatible with all tape-fed automatic pick-and-place systems.

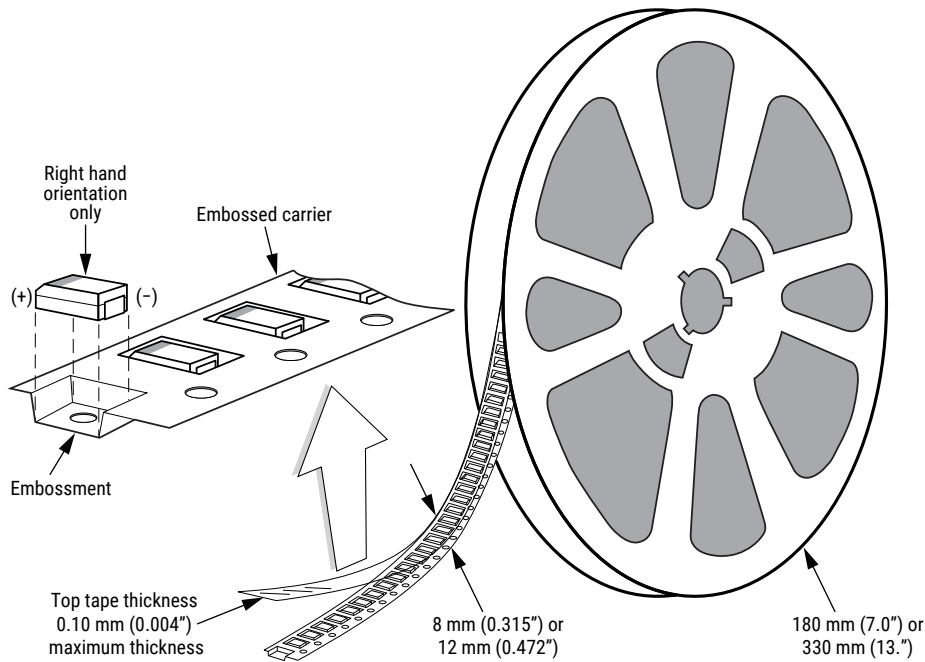

Table 3 – Packaging Quantity

Case Code		Tape Width (mm)	7" Reel*	13" Reel*
KEMET	EIA			
D	7343-31	12	500	2,500
V	7343-21	12	1,000	3,000

* No C-Spec required for 7" reel packaging. C-7280 required for 13" reel packaging.

Aluminum Organic Capacitor (AO-CAP)

A798 High Humidity and High Temperature Polymer Aluminum

Figure 1 – Embossed (Plastic) Carrier Tape Dimensions

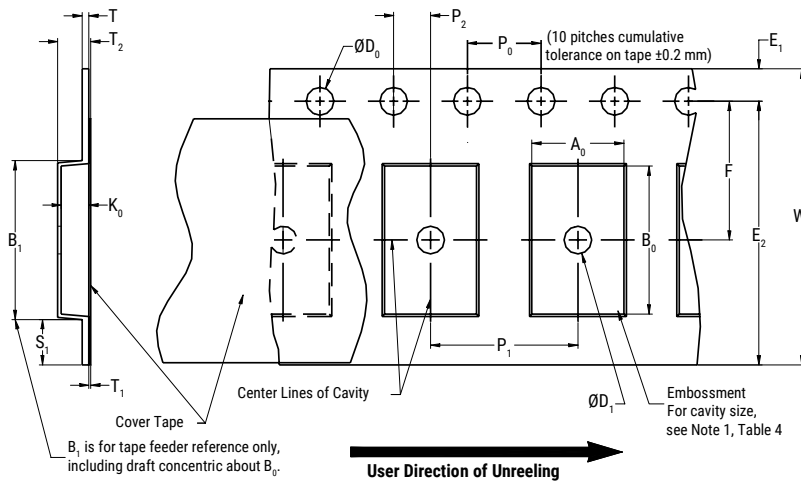

Table 4 – Embossed (Plastic) Carrier Tape Dimensions

Metric will govern

Constant Dimensions – Millimeters (Inches)									
Tape Size	D_0	D_1 Minimum Note 1	E_1	P_0	P_2	R Reference Note 2	S_1 Minimum Note 3	T Maximum	T_1 Maximum
8 mm	$1.5 \pm 0.10 / -0.0$ (0.059 + 0.004 / -0.0)	1.0 (0.039)	1.75 ± 0.10 (0.069 ± 0.004)	4.0 ± 0.10 (0.157 ± 0.004)	2.0 ± 0.05 (0.079 ± 0.002)	25.0 (0.984)	0.600 (0.024)	0.600 (0.024)	0.100 (0.004)
12 mm		1.5 (0.059)							
Variable Dimensions – Millimeters (Inches)									
Tape Size	Pitch	B_1 Maximum Note 4	E_2 Minimum	F	P_1	T_2 Maximum	W Maximum	A_0, B_0 & K_0	
8 mm	Single (4 mm)	4.35 (0.171)	6.25 (0.246)	3.5 ± 0.05 (0.138 ± 0.002)	4.0 ± 0.10 (0.157 ± 0.004)	2.5 (0.098)	8.3 (0.327)	Note 5	
12 mm	Single (4 mm) and Double (8 mm)	8.2 (0.323)	10.25 (0.404)	5.5 ± 0.05 (0.217 ± 0.002)	4.0 ± 0.10 (0.157 ± 0.004) or 8.0 ± 0.10 (0.315 ± 0.004)	4.6 (0.181)	12.3 (0.484)		

1. The embossment hole location shall be measured from the sprocket hole controlling the location of the embossment. Dimensions of embossment location and hole location shall be applied independent of each other.
2. The tape, with or without components, shall pass around R without damage (see Figure 4).
3. If $S_1 < 1.0$ mm, there may not be enough area for cover tape to be properly applied (see EIA Standard 481-D, paragraph 4.3, section b).
4. B_1 dimension is a reference dimension for tape feeder clearance only.
5. The cavity defined by A_0, B_0 and K_0 shall surround the component with sufficient clearance that:
 - (a) the component does not protrude above the top surface of the carrier tape.
 - (b) the component can be removed from the cavity in a vertical direction without mechanical restriction, after the top cover tape has been removed.
 - (c) rotation of the component is limited to 20° maximum for 8 and 12 mm tapes (see Figure 2).
 - (d) lateral movement of the component is restricted to 0.5 mm maximum for 8 mm and 12 mm wide tape (see Figure 3).
 - (e) see Addendum in EIA Standard 481-D for standards relating to more precise taping requirements.

Packaging Information Performance Notes

- 1. Cover tape break force:** 1.0 kg minimum.
- 2. Cover tape peel strength:** The total peel strength of the cover tape from the carrier tape shall be:

Tape Width	Peel Strength
8 mm	0.1 to 1.0 newton (10 to 100 gf)
12 mm	0.1 to 1.3 newton (10 to 130 gf)

The direction of the pull shall be opposite the direction of the carrier tape travel. The pull angle of the carrier tape shall be 165° to 180° from the plane of the carrier tape. During peeling, the carrier and/or cover tape shall be pulled at a velocity of 300 ±10 mm/minute.

3. Labeling: Bar code labeling (standard or custom) shall be on the side of the reel opposite the sprocket holes. Refer to EIA Standards 556 and 624.

Figure 2 – Maximum Component Rotation

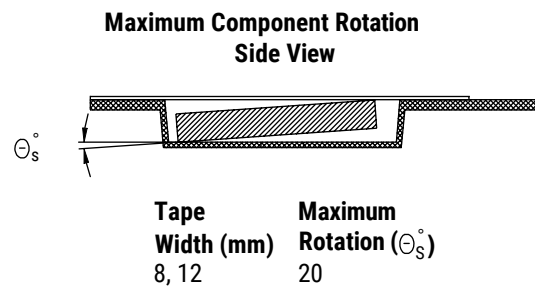
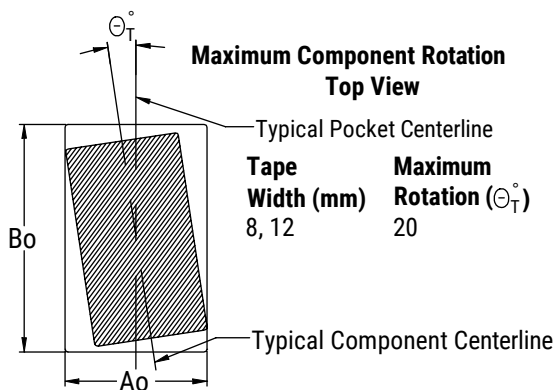

Figure 3 – Maximum Lateral Movement

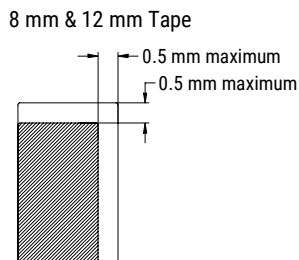
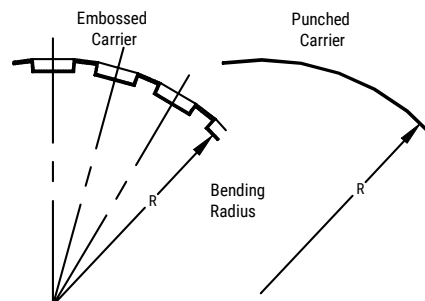

Figure 4 – Bending Radius



Aluminum Organic Capacitor (AO-CAP)

A798 High Humidity and High Temperature Polymer Aluminum

Figure 5 – Reel Dimensions

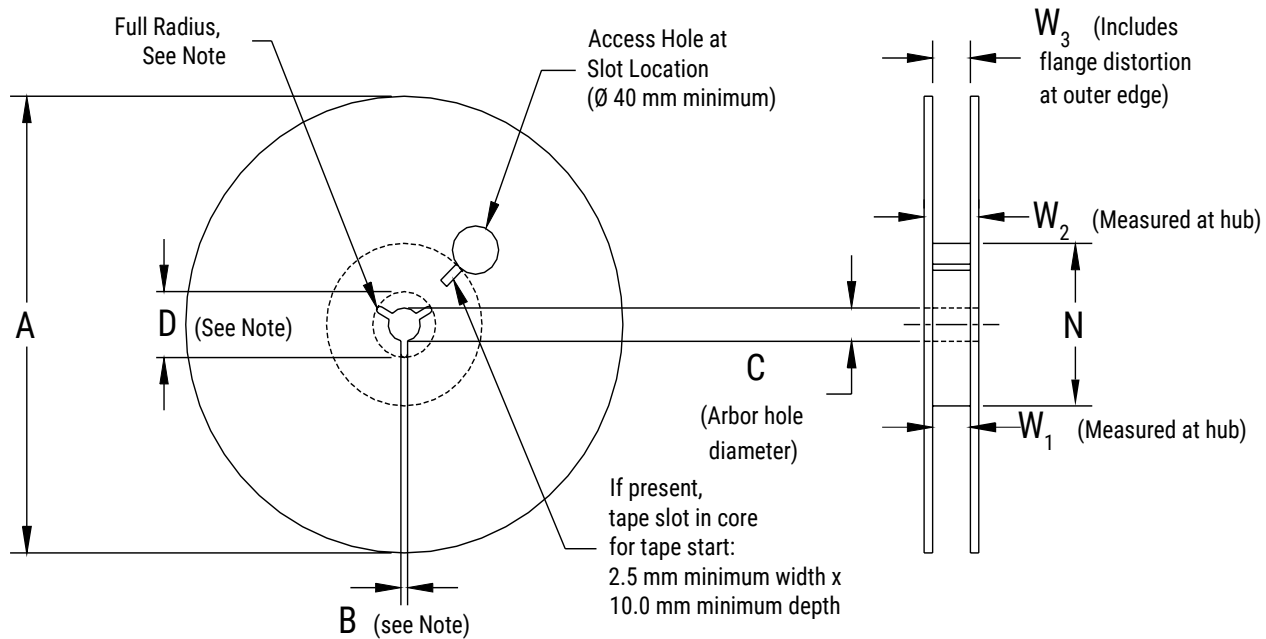

Table 5 – Reel Dimensions

Metric will govern

Constant Dimensions – Millimeters (Inches)				
Tape Size	A	B Minimum	C	D Minimum
8 mm	178 ±0.20 (7.008 ±0.008)	1.5 (0.059)	13.0 +0.5/-0.2 (0.521 +0.02/-0.008)	20.2 (0.795)
12 mm	330 ±0.20 (13.000 ±0.008)			
Variable Dimensions – Millimeters (Inches)				
Tape Size	N Minimum	W ₁	W ₂ Maximum	W ₃
8 mm	50 (1.969)	8.4 +1.5/-0.0 (0.331 +0.059/-0.0)	14.4 (0.567)	Shall accommodate tape width without interference
12 mm		12.4 +2.0/-0.0 (0.488 +0.078/-0.0)	18.4 (0.724)	

Aluminum Organic Capacitor (AO-CAP)

A798 High Humidity and High Temperature Polymer Aluminum

Figure 6 – Tape Leader & Trailer Dimensions

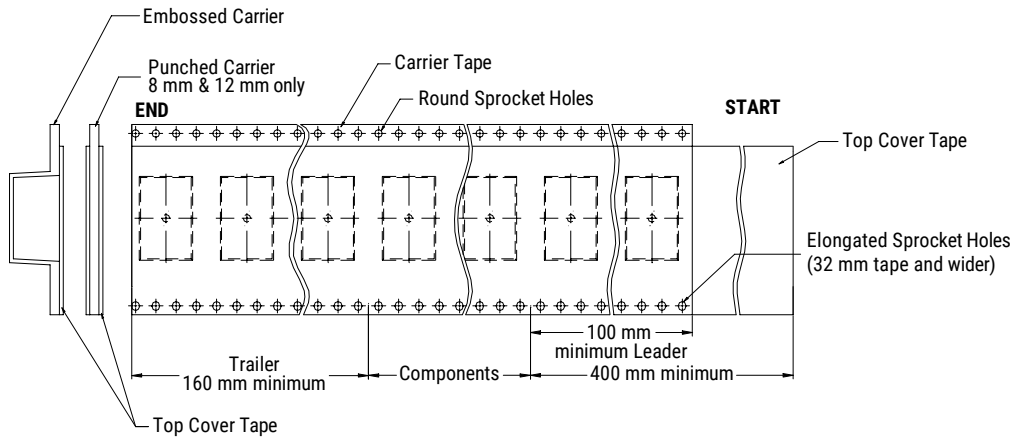
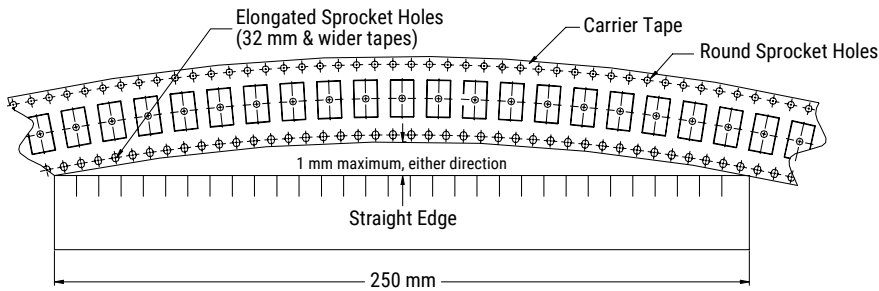

Figure 7 – Maximum Camber



Aluminum Organic Capacitor (AO-CAP)

A798 High Humidity and High Temperature Polymer Aluminum

KEMET Electronics Corporation Sales Offices

For a complete list of our global sales offices, please visit <https://www.yageogroup.com/SalesResources/SalesOffices>

Disclaimer

YAGEO Corporation and its affiliates do not recommend the use of commercial or automotive grade products for high reliability applications or manned space flight.

All product specifications, statements, information and data (collectively, the "Information") in this datasheet are subject to change. The customer is responsible for checking and verifying the extent to which the Information contained in this publication is applicable to an order at the time the order is placed. All Information given herein is believed to be accurate and reliable, but it is presented without guarantee, warranty, or responsibility of any kind, expressed or implied.

Statements of suitability for certain applications are based on KEMET Electronics Corporation's ("KEMET") knowledge of typical operating conditions for such applications, but are not intended to constitute – and KEMET specifically disclaims – any warranty concerning suitability for a specific customer application or use. The Information is intended for use only by customers who have the requisite experience and capability to determine the correct products for their application. Any technical advice inferred from this Information or otherwise provided by KEMET with reference to the use of KEMET's products is given gratis, and KEMET assumes no obligation or liability for the advice given or results obtained.

Although KEMET designs and manufactures its products to the most stringent quality and safety standards, given the current state of the art, isolated component failures may still occur. Accordingly, customer applications which require a high degree of reliability or safety should employ suitable designs or other safeguards (such as installation of protective circuitry or redundancies) in order to ensure that the failure of an electrical component does not result in a risk of personal injury or property damage.

Although all product-related warnings, cautions and notes must be observed, the customer should not assume that all safety measures are indicated or that other measures may not be required.

KEMET is a registered trademark of KEMET Electronics Corporation.