

DATA SHEET

SMD 2410 FAST ACTING FUSE JC24F Series

RoHS compliant & Halogen free



Product specification- January 20, 2026 V.1



JC24F Series DataSheet

Scope

This specification is applicable to over-current protection wire in air fuse for 2410 fast acting series produced by YAGEO corporation.

Applications

- Storage system
- PC server
- Telecom system
- Cooling fan system

Features

- High inrush withstand capability
- Wire-in-air performance
- Operating temperature -55°C to 125°C
- Excellent long-term stability
- Halogen Free
- Lead Free

Agency Approval

Agency	File Number	Ampere Range
	E531845	1A-30A

Dimensions

Series	L (mm)	W (mm)	T (mm)	D (mm)
JC24F	6.1±0.3	2.6±0.2	2.6±0.2	1.6±0.2

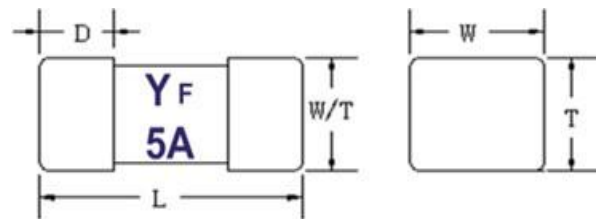

Notes: The electrodes are assembled with an interference fit on tube, so gaps up to 0.3 mm do not affect performance or reliability.

Recommended Land Patterns

Series	A (mm)	B (mm)	C (mm)	D (mm)
JC24F	3.0±0.3	8.0±0.3	3.0±0.3	2.5±0.3

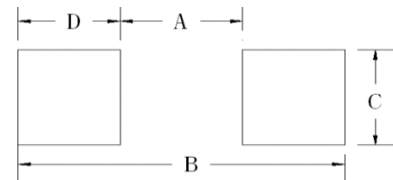

Ordering Information

Part Number	Current Rating (A)	Voltage Rating (Vdc)	Interrupting	Typical DCR (mΩ) ¹	Typical I ² t (A ² s) ²
JC24F1001R	1A	125Vdc	100A@125Vdc	111	0.43
JC24F1251R	1.25A			78.2	0.53
JC24F1601R	1.6A			61.5	0.85
JC24F2001R	2A			39.6	1.07
JC24F2501R	2.5A			33.3	1.52
JC24F3151R	3.15A			23.1	2.08
JC24F4001R	4A			16.5	3.59
JC24F5001R	5A			13.4	6.12
JC24F6301R	6.3A			9.85	10.7
JC24F7001R	7A			8.32	15.3
JC24F8001R	8A			7.15	22.4
JC24F1002R	10A			5.15	41.2
JC24F1202R	12A			65Vdc	100A@65Vdc
JC24F1502R	15A	3.38	82		
JC24F2002R	20A	3.00	214		
JC24F3002R	30A	1.40	550		

SMD 2410 Fast Acting Fuse

JC24F Series

- NOTE:**1. Measured at $\leq 10\%$ rated current and 25°C
 2. Nominal Melting I^2t measured at 0.01 sec opening time

Clearing Time Characteristics

Rated Current	% of Current Rating	Clearing Time at 25°C	
		Min	Max
1A-30A	100%	4hours	/
	200%	/	60s

Part Number Code Rule

J	C	24	F	1001	R
Product Code	Product Type	Size Type	Fusing Type	Current Rating	Package
J:Fuse	C: Ceramics	24:2410	F: Fast Acting	1001:1A 1002:10A	R:Tape and Reel B: Bulk

Temperature Derating Curve

When choosing the fuse is specification, if the operating environmental temperature beyond the scope from $20\sim 30^{\circ}\text{C}$, you should consider the environmental temperature is affection to fuses. please refer:

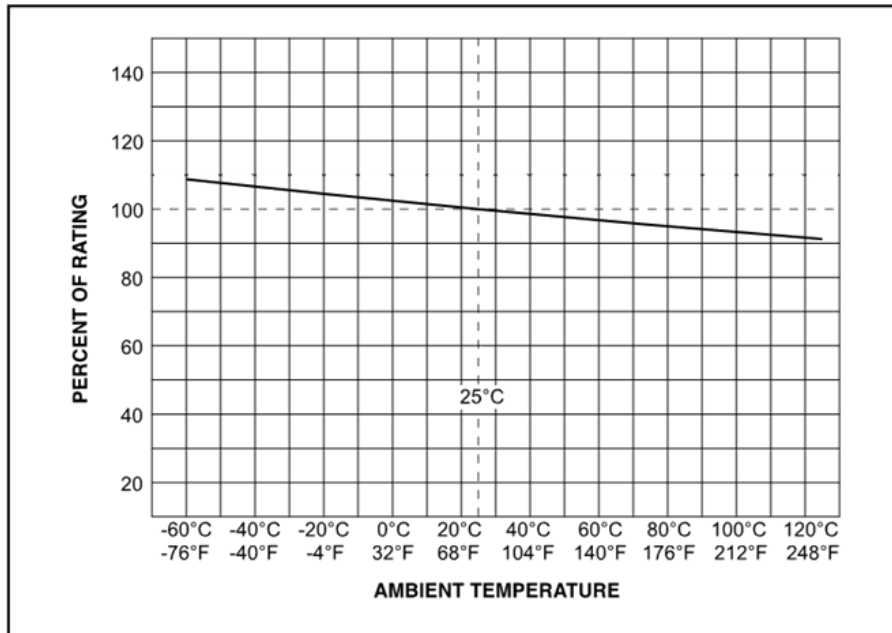

SMD 2410 Fast Acting Fuse

JC24F Series

Time & Current Curve

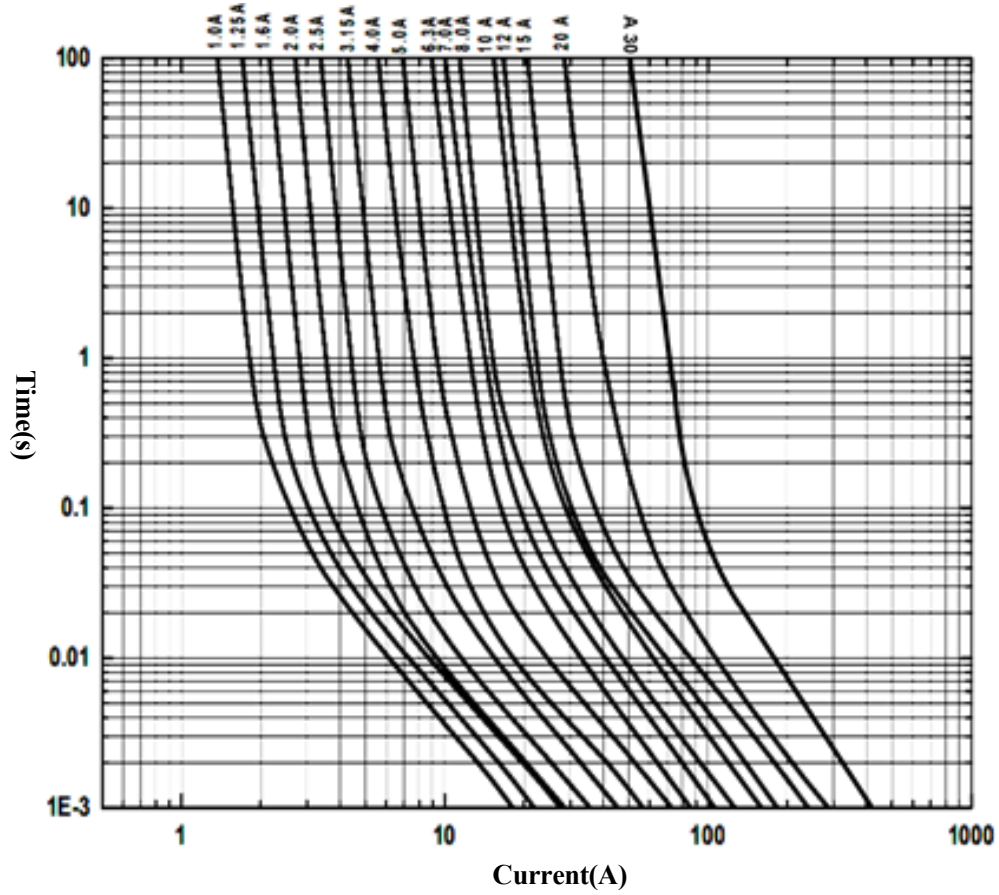

I²t & Time Curve

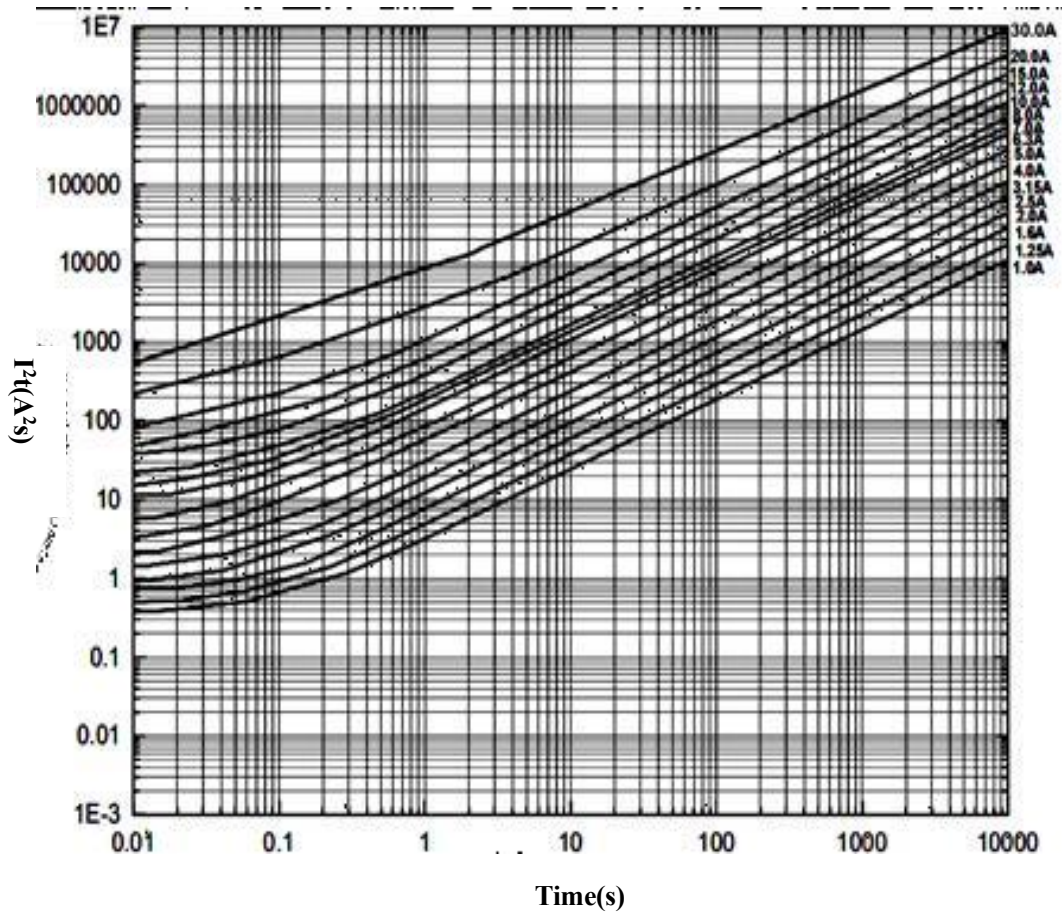

Reliability Test Performance

Item	Test condition/ Methods	Performance	Standard
Time/Current Characteristics	100% Rated Current	No fusing within 4hr	UL248-14
	200% Rated Current	Max:60s	Refer to clearing time characteristics
Breaking Capacity	1A-10A: 100A@125Vdc 12A-30A: 100A@65Vdc	No a permanent arcing, ignition, bursting	UL248-14
Solderability	T=245°C±5°C, t=5s±0.5s	Cover ≥95%	MIL-STD-202 Method 208
Resistance to Soldering	Pre-heating:145°±15°C, max.120s Peak: 260°C, max.10s Reflow cycle: 2 times After immersion into solder, leaving the room temp. for 1h or more, and then measure the internal resistance.	△R<15% No crack and damage, Marking is easily legible	MIL-STD-202, Method 210F
Thermal Shock	-65°C, 15min→25°C, 5min→+125°C, 15min ; 100 cycles	△R<10% No crack and damage,	MIL-STD-202, Method 213B
Mechanical Shock	a=100G for 11ms, 5pulses	△R<10% No crack and damage	MIL-STD-202, Method 213B
Vibration	Frequency range:10~15~10Hz/min Vibration amplitude:1.5mm	△R<10% No mechanical damages	MIL-STD-202, Method 201A
Salt Spray	5% salt solution,48hr	△R<10% Legible appearance	MIL-STD-202, Method 101
Board Flex	Bending:1mm, time:60s	△R<15% No mechanical damages	IEC 60127-4

Soldering Condition

Recommend Re-Flowing Profile

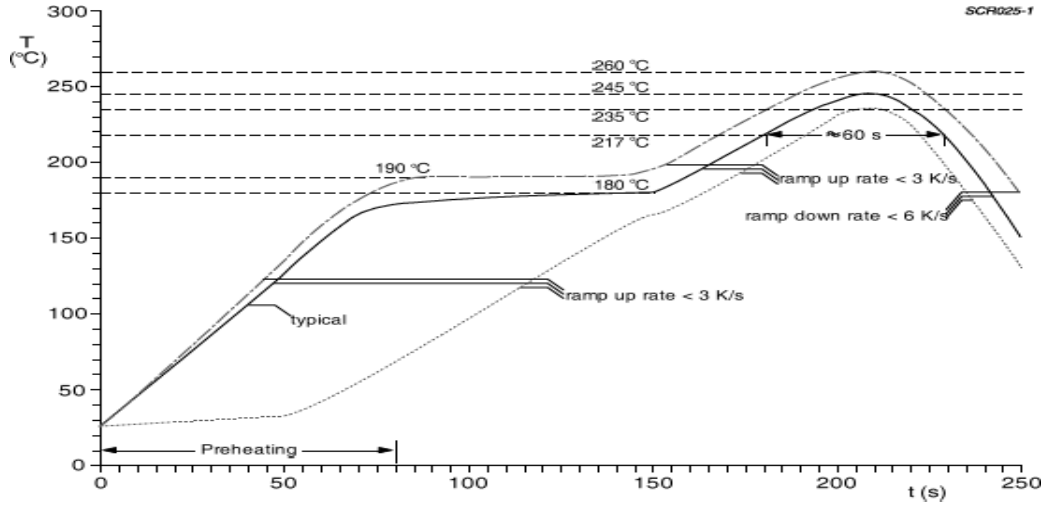

Item	Condition
Ramp	$< 3^{\circ}\text{C/sec.}$
Pre-heating	$145 \pm 15^{\circ}\text{C}$, 120s max.
Time above 220°C	60s max.
Peak temperature	$260^{\circ}\text{C}/10\text{s}$ max.

Recommend Soldering tip Temperature

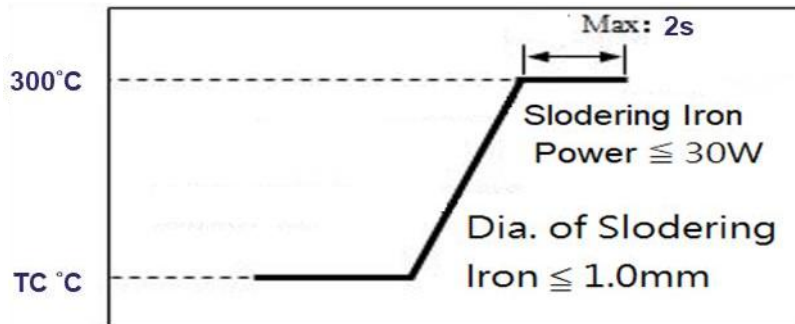

Item	Condition
Iron soldering power	Max. 30W
Pre-heating time	60sec, 150°C
Soldering tip temperature	Max. 350°C
Soldering time	Max. 2sec

Note: Take care not to apply the tip of the soldering iron to the terminal electrodes.

SMD 2410 Fast Acting Fuse

JC24F Series

Packaging Specification

■ Quantity & Weight

Series	Quantity
JC24F	1000pcs/Reel

■ Reel & Tape Specification

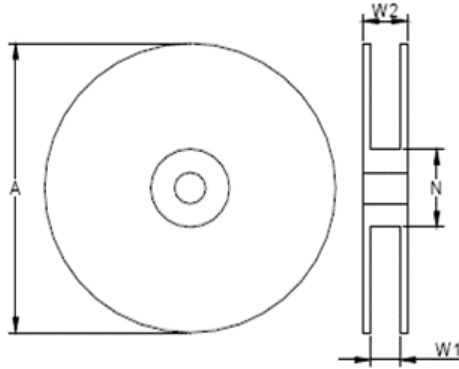

Series	A (mm)	N (mm)	W1 (mm)	W2 (mm)
JC24F	178±2	58±2	12.5±1	14.5±1.5

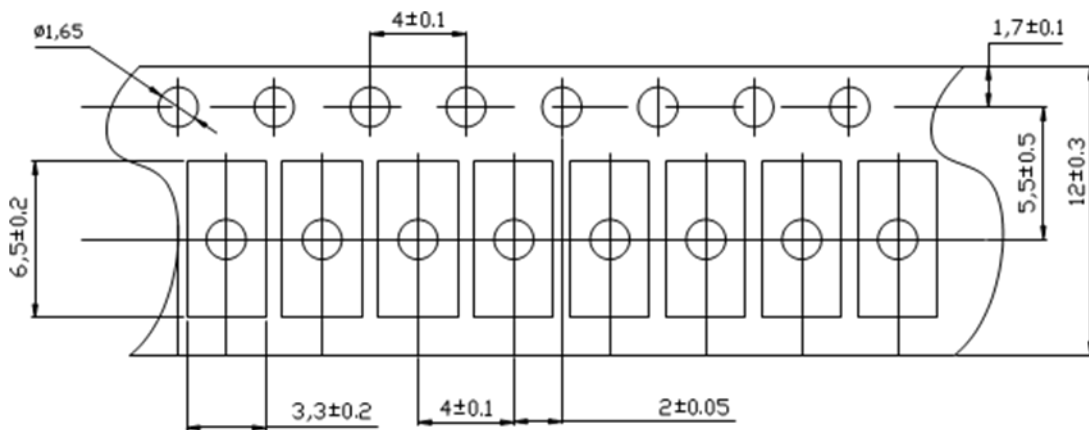

■ Peeling Strength of Seal Tape

The top cover tape is pulled at a speed of 300 mm/min with the angle between the tape during peel and the direction of unreeling maintained at 165 to 180 degree as following picture. The peel force of paper carrier tape shall be 0.1N to 1.0N(10 to 100 g)

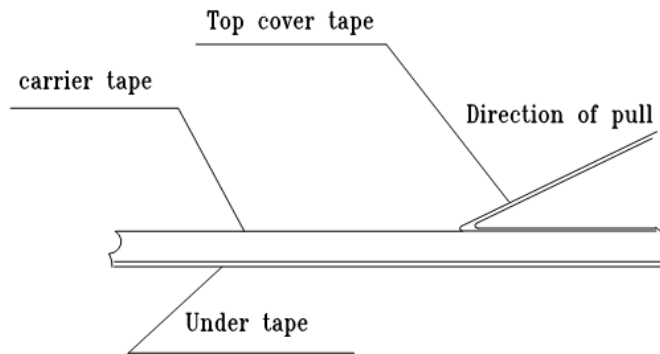

Storage Conditions

- Storage Temperature: 10°C~+40°C
- Relative Humidity: ≤75%RH
- Keep away from corrosive atmosphere and sunlight.
- Period of Storage: 2 year.

LEGAL DISCLAIMER

YAGEO, its distributors and agents (collectively, "YAGEO"), hereby disclaims any and all liabilities for any errors, inaccuracies or incompleteness contained in any product related information, including but not limited to product specifications, datasheets, pictures and/or graphics. YAGEO may make changes, modifications and/or improvements to product related information at any time and without notice.

YAGEO makes no representation, warranty, and/or guarantee about the fitness of its products for any particular purpose or the continuing production of any of its products. To the maximum extent permitted by law, YAGEO disclaims (i) any and all liability arising out of the application or use of any YAGEO product, (ii) any and all liability, including without limitation special, consequential or incidental damages, and (iii) any and all implied warranties, including warranties of fitness for a particular purpose, non-infringement and merchantability.

YAGEO products are designed for general purpose applications under normal operation and usage conditions. Please contact YAGEO for the applications listed below which require especially high reliability for the prevention of defects which might directly cause damage to the third party's life, body or property: Aerospace equipment (artificial satellite, rocket, etc.), Atomic energy-related equipment, Aviation equipment, Disaster prevention equipment, crime prevention equipment, Electric heating apparatus, burning equipment, Highly public information network equipment, data-processing equipment, Medical devices, Military equipment, Power generation control equipment, Safety equipment, Traffic signal equipment, Transportation equipment and Undersea equipment, or for any other application or use in which the failure of YAGEO products could result in personal injury or death, or serious property damage. Particularly **YAGEO Corporation and its affiliates do not recommend the use of commercial or automotive grade products for high reliability applications or manned space flight.**

Information provided here is intended to indicate product specifications only. YAGEO reserves all the rights for revising this content without further notification, as long as products are unchanged. Any product change will be announced by PCN.

UL Product **iQ**[®]



JDYX.E531845 - Fuses, Supplemental

Fuses, Supplemental

YAGEO CORP

3Rd Fl, #233-1
 Baoqiao Rd
 Xindian
 New Taipei, 231 Taiwan

E531845

Cat. No.	Size mm(in)	Amps (A)	Volts (V)	Interrupting Rating (A)
Supplemental micro fuses: surface mount				
JC24F	6.5 x 2.8 x 2.8 (0.26 x 0.11 x 0.11)	0.05-30	300Vac	100
		0.05-30	250Vac	100
		0.05-30	125Vac	100
		0.05-30	125Vdc	100
		0.05-30	65Vdc	100
JC24S	6.5 x 2.8 x 2.8 (0.26 x 0.11 x 0.11)	0.05-30	300Vac	100
		0.05-30	250Vac	100
		0.05-30	125Vac	100
		0.05-30	125Vdc	100
		0.05-30	65Vdc	100

Last Updated on 2022-12-12