

Power Inductor

BPSD Series



Overview

Power inductors are passive electronic components used in various circuits to store energy in a magnetic field when electrical current flows through them. They are critical in filtering, energy storage, and noise suppression in power electronic systems. They are designed to handle higher currents and are optimized for minimal power loss and thermal efficiency.

Benefits

1. Ferrite SMD Shielded Type
2. Unshielded power inductor
3. Various package size and wide inductance range

Applications

1. Graphic cards
2. DC/DC converters

Product Information

Series	L (mm)	W(mm)	T (mm)	Inductance (μH)
BPSD	3.3	3.0	1.5	0.15 ~ 8200
	3.3	3.0	2.1	
	4.5	4.0	3.2	
	5.8	5.2	2.5	
	5.8	5.2	3.0	
	5.8	5.2	4.5	
	7.8	7.0	3.5	
	7.8	7.0	5.0	
	10	9.0	4.0	
	10	9.0	5.4	
	10	9.0	6.5	



BPSD00060530 Series Specification

1 Scope: This specification applies to SMD Unshielded Power Inductors

2 Part Numbering:

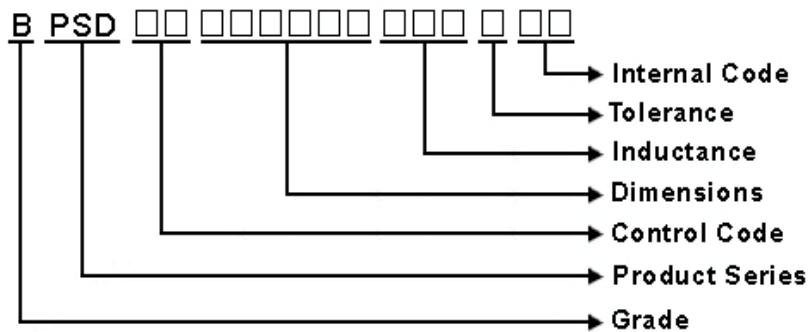

3 Rating:

Operating Temperature: $-40^{\circ}\text{C} \sim +125^{\circ}\text{C}$ (Including self temp. rise)

Storage Temperature: $-40^{\circ}\text{C} \sim +125^{\circ}\text{C}$ (For after the circuit board is mounted)

Storage Temperature: (on tape & reel): -20°C to $+40^{\circ}\text{C}$; 75% RH max.

4 Marking:

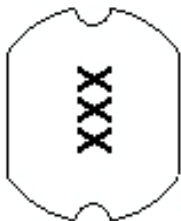

Ex Marking : 100

Marking color : Black

5 Standard Testing Condition

	Unless otherwise specified	In case of doubt
Temperature	Ordinary Temperature(15 to 35°C)	20 to 30°C
Humidity	Ordinary Humidity(25 to 85% RH)	50 to 80 %RH

BPSD00060530 Series Specification

6 Configuration and Dimensions and Unit Weight:

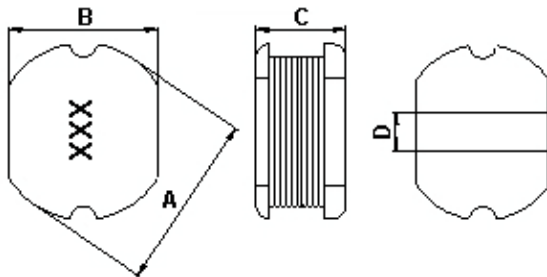

Dimensions in mm

TYPE	060530
A	5.8±0.3
B	5.2±0.3
C	3.0±0.3
D	2.0

Net Weight (grms)

SIZE CODE	Net Weight (grms)
060530	0.31(Typ.)

7 Electrical Characteristics:

Part No.	Inductance (uH)	Test Freq.	RDC (Ω)Max.	Isat (A)	Irms (A)	Tolerance (±%)	Marking
BPSD000605301R0□00	1	7.96 MHz,1 V	0.03	4.5	4.5	20	1R0
BPSD000605301R2□00	1.2	7.96 MHz,1 V	0.03	4.2	4.2	20	1R2
BPSD000605301R5□00	1.5	7.96 MHz,1 V	0.03	4.1	4.1	20	1R5
BPSD000605301R8□00	1.8	7.96 MHz,1 V	0.03	3.7	3.7	10,20	1R8
BPSD000605302R0□00	2	7.96 MHz,1 V	0.03	3.6	3.6	20	2R0
BPSD000605302R2□00	2.2	7.96 MHz,1 V	0.03	3.5	3.5	20	2R2
BPSD000605302R7□00	2.7	7.96 MHz,1 V	0.04	3.2	3.2	20	2R7
BPSD000605303R3□00	3.3	7.96 MHz,1 V	0.05	2.8	2.8	10,20	3R3
BPSD000605303R9□00	3.9	7.96 MHz,1 V	0.06	2.6	2.6	20	3R9
BPSD000605304R7□00	4.7	7.96 MHz,1 V	0.07	2.5	2.5	10,20	4R7
BPSD000605305R6□00	5.6	7.96 MHz,1 V	0.08	2.4	2.4	20	5R6
BPSD000605306R8□00	6.8	7.96 MHz,1 V	0.09	2.2	2.2	20	6R8
BPSD000605308R2□00	8.2	7.96 MHz,1 V	0.1	2	2	20	8R2
BPSD00060530100□00	10	2.52 MHz,1 V	0.12	1.8	1.8	10,20	100
BPSD00060530120□00	12	2.52 MHz,1 V	0.13	1.75	1.75	10,20	120
BPSD00060530150□00	15	2.52 MHz,1 V	0.15	1.7	1.7	10,20	150
BPSD00060530180□00	18	2.52 MHz,1 V	0.22	1.6	1.6	10,20	180
BPSD00060530220□00	22	2.52 MHz,1 V	0.22	1.5	1.5	10,20	220
BPSD00060530270□00	27	2.52 MHz,1 V	0.26	1.4	1.4	20	270
BPSD00060530330□00	33	2.52 MHz,1 V	0.33	1.1	1.1	10,20	330
BPSD00060530390□00	39	2.52 MHz,1 V	0.42	1	1	10,20	390
BPSD00060530470□00	47	2.52 MHz,1 V	0.5	0.9	0.9	10,20	470
BPSD00060530560□00	56	2.52 MHz,1 V	0.55	0.85	0.85	10,20	560
BPSD00060530680□00	68	2.52 MHz,1 V	0.65	0.8	0.8	10,20	680
BPSD00060530820□00	82	2.52 MHz,1 V	0.8	0.65	0.65	10,20	820

NOTE: □-tolerance K=±10% / M=±20%

1. Operating temperature range - 4 0 °C ~ 1 2 5 °C(Including self - temperature rise)
2. Isat for Inductance drop 10% from its value without current.
3. Iirms for a 40°C temperature rise from 25°C ambient.

BPSD00060530 Series Specification

Part No.	Inductance (μ H)	Test Freq.	RDC (Ω)Max.	Isat (A)	Irms (A)	Tolerance (\pm %)	Marking
BPSD00060530101□00	100	1 kHz,1 V	0.9	0.6	0.6	10,20	101
BPSD00060530121□00	120	1 kHz,1 V	1	0.58	0.58	10,20	121
BPSD00060530151□00	150	1 kHz,1 V	1.3	0.43	0.43	10,20	151
BPSD00060530181□00	180	1 kHz,1 V	1.5	0.41	0.41	10,20	181
BPSD00060530221□00	220	1 kHz,1 V	2	0.38	0.38	10,20	221
BPSD00060530271□00	270	1 kHz,1 V	2.5	0.35	0.35	10,20	271
BPSD00060530331□00	330	1 kHz,1 V	3.2	0.28	0.28	10,20	331
BPSD00060530391□00	390	1 kHz,1 V	3.5	0.26	0.26	10,20	391
BPSD00060530471□00	470	1 kHz,1 V	4.2	0.2	0.2	10,20	471
BPSD00060530561□00	560	1 kHz,1 V	4.5	0.19	0.19	10,20	561
BPSD00060530681□00	680	1 kHz,1 V	6.5	0.18	0.18	10,20	681
BPSD00060530821□00	820	1 kHz,1 V	7.5	0.15	0.15	10,20	821
BPSD00060530102□00	1000	1 kHz,1 V	8	0.13	0.13	10,20	102

BPSD00060530 Series Specification

8 BPSD00060530 Series

8.1 Construction:

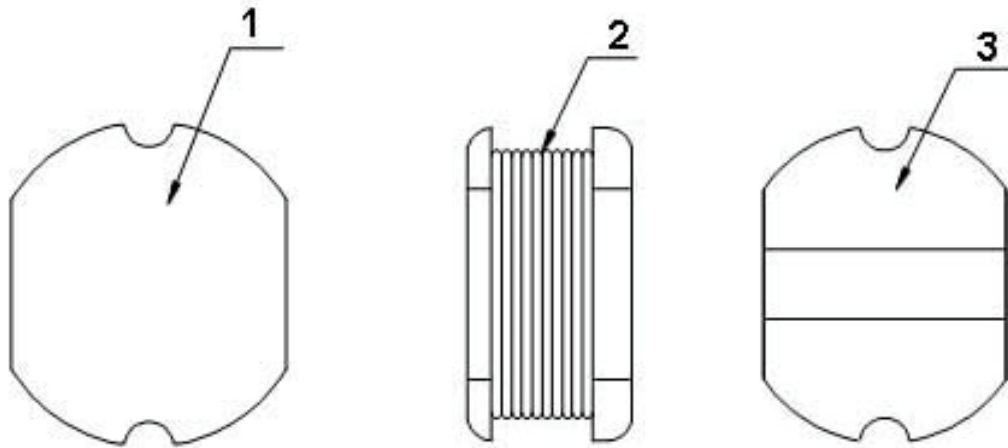

8.2 Material List:

No	Part	Material
1	CORE	FERRITE
2	WIRE	MAGNET WIRE
3	TERMINAL	Ag/Ni/Sn

BPSD00060530 Series Specification

9 Reliability Of Ferrite Wire Wound Power Inductor

1-1.Mechanical Performance

No	Item	Specification	Test Method
1-1-1	Vibration	Appearance: No damage Inductance: within $\pm 10\%$ of initial value	Test device shall be soldered on the substrate Oscillation Frequency: 10 to 55 to 10Hz for 1min Amplitude: 1.5mm Time: 2hrs for each axis (X, Y & Z), total 6hrs
1-1-2	Resistance to Soldering Heat	Appearance: No damage	Pre-heating: 150°C, 1min Solder Composition: Sn/Ag3.0/Cu0.5 Solder Temperature: 260 \pm 5°C Immersion Time: 10 \pm 1sec
1-1-3	Solder ability	The electrodes shall be at least 95% covered with new solder coating	Pre-heating: 150°C, 1min Solder Composition: Sn/Ag3.0/Cu0.5 Solder Temperature: 245 \pm 5°C Immersion Time: 4 \pm 1sec
1-1-4	Resistance to solvent	There must be no change in appearance or obliteration of marking.	Inductors must withstand 6 minutes of alcohol or water.

1-2.Environmental Performance

No	Item	Specification	Test Method															
1-2-1	Temperature Shock	Appearance: No damage Inductance: within $\pm 10\%$ of initial value	10 cycles (Air to Air) 1 cycles shall consist of: 30 minutes exposure to -55 °C 30 minutes exposure to 125 °C 15 seconds maximum transition between temperatures															
1-2-2	Temperature Cycle		One cycle: <table border="1"> <thead> <tr> <th>Step</th> <th>Temperature (°C)</th> <th>Time (min)</th> </tr> </thead> <tbody> <tr> <td>1</td> <td>-40\pm3</td> <td>30</td> </tr> <tr> <td>2</td> <td>25\pm2</td> <td>3</td> </tr> <tr> <td>3</td> <td>125\pm3</td> <td>30</td> </tr> <tr> <td>4</td> <td>25\pm2</td> <td>3</td> </tr> </tbody> </table>	Step	Temperature (°C)	Time (min)	1	-40 \pm 3	30	2	25 \pm 2	3	3	125 \pm 3	30	4	25 \pm 2	3
Step	Temperature (°C)	Time (min)																
1	-40 \pm 3	30																
2	25 \pm 2	3																
3	125 \pm 3	30																
4	25 \pm 2	3																
1-2-3	Humidity Resistance		Total: 100cycles Measured after exposure in the room condition for 24hrs Temperature: 40 \pm 2°C Relative Humidity: 90 ~ 95% Time: 1000hrs Measured after exposure in the room condition for 24hrs															
1-2-4	Heat Life		Temperature: 85 \pm 3°C Applied Current: Rated Current Time: 1000hrs Measured after exposure in the room condition for 24hrs															
1-2-5	Cold Resistance		Temperature: -40 \pm 3°C Time: 1000hrs Measured after exposure in the room condition for 24hrs															

BPSD00060530 Series Specification

Reflow Soldering Profile

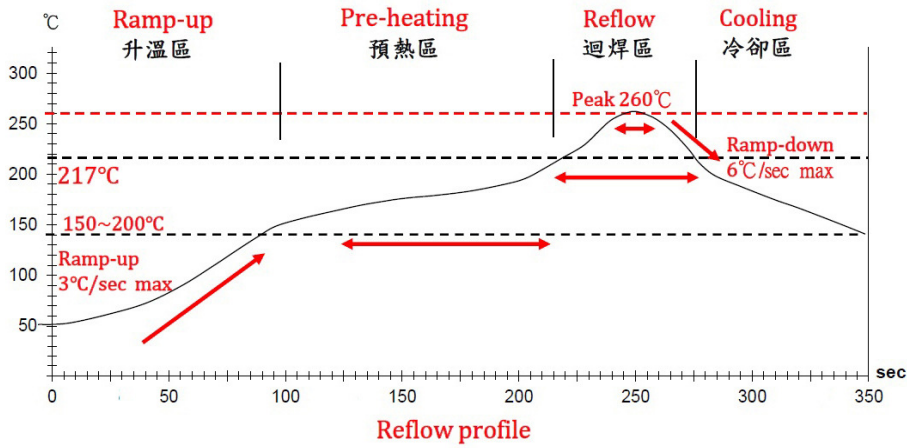

Lead-Free(LF)標準溫度分析範圍

Refer to J-STD-020C

管制項目 Item.	升溫區 Ramp-up	預熱區 Pre-heating	迴焊區 Reflow	Peak Temp	冷卻區 Cooling
溫度範圍 Temp.scope	R.T ~ 150°C	150°C ~ 200°C	217°C	260±5°C	Peak Temp.~150°C
標準時間 Time spec.	-	60 ~ 180 sec	60 ~ 150 sec	20 ~ 40 sec	-
實際時間 Time result	-	75 ~ 100 sec	90 ~ 120 sec	20 ~ 35 sec	-

BPSD00060530 Series Specification

10 Packaging:

10.1 Packaging -Cover Tape

The force for tearing off cover tape is 10 to 130 grams in the arrow direction.

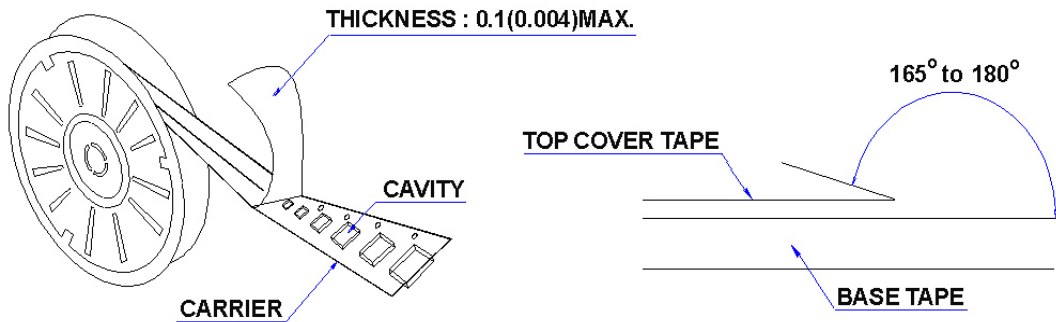

10.2 Packaging Quantity

TYPE	PCS/REEL
060530	2000

10.3 Reel Dimensions

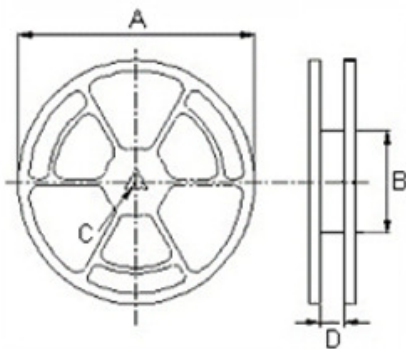

Dimensions in mm

TYPE	A	B	C	D
060530	330	100	13	16

BPSD00060530 Series Specification

10 Packaging:

10.4 Tape Dimensions in mm

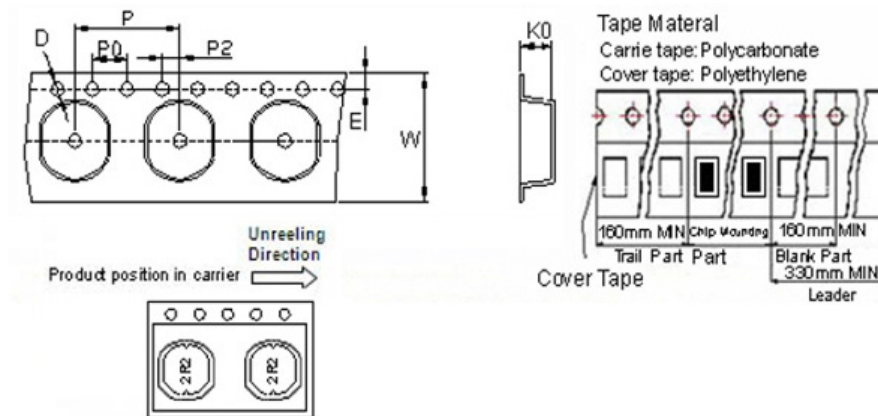

TYPE	K0	D	E	W	P	P0	P2
060530	3.30	1.50	1.75	16	8	4	2

11 Recommended Land Pattern:

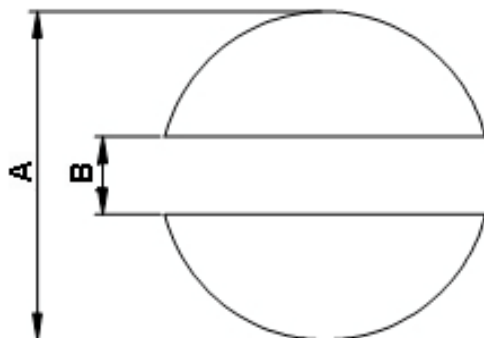

Dimensions in mm

TYPE	A	B
060530	6.8	2.0

12 Note:

1. Please make sure that your product has been evaluated and confirmed against your specifications when our product is mounted to your product.
2. Do not knock nor drop.
3. All the items and parameters in this product specification have been prescribed on the premise that our product is used for the purpose, under the condition and in the environment agreed upon between you and us. You are requested not to use our product deviating from such agreement.
4. Please keep the distance between transformer/coil and other components (refer to the standard IEC 950)
5. The moisture sensitivity level (MSL) of products is classified as level 1.

BPSD00060530 Series Specification

13 Graph:

BPSD000605301R0□00

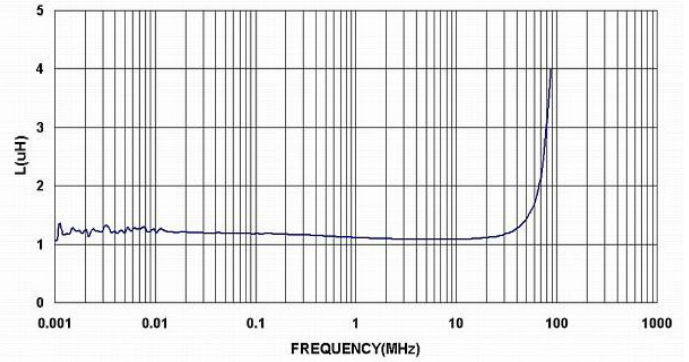
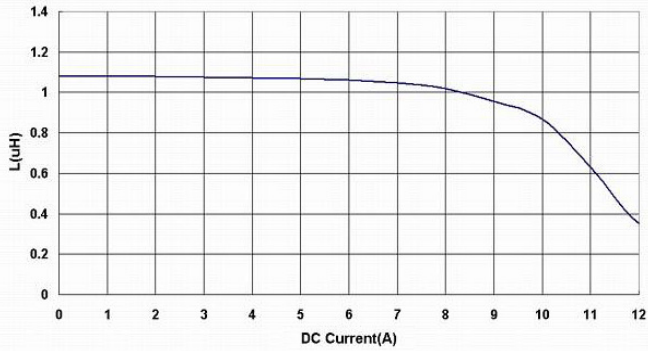

BPSD000605301R2□00

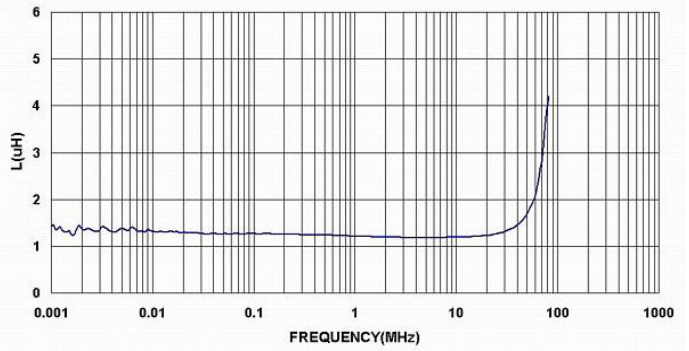
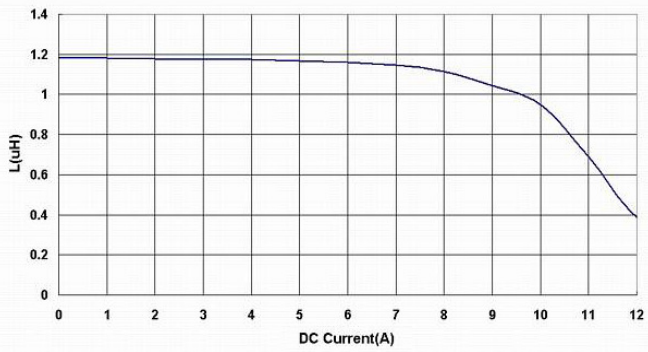

BPSD000605301R5□00

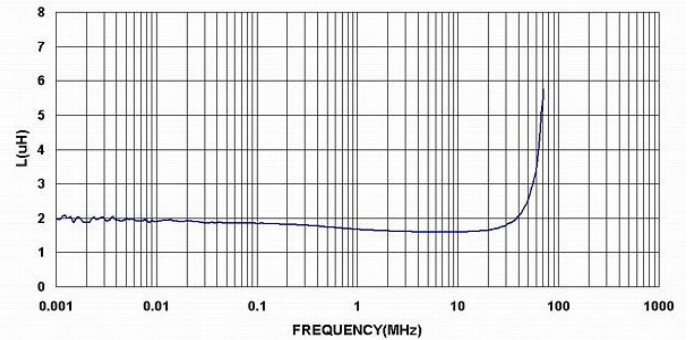
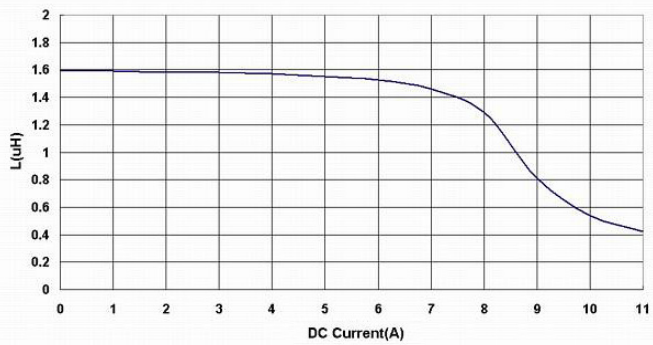

BPSD000605301R8□00

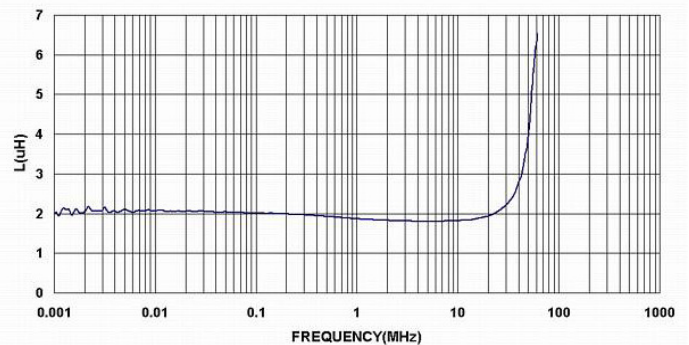
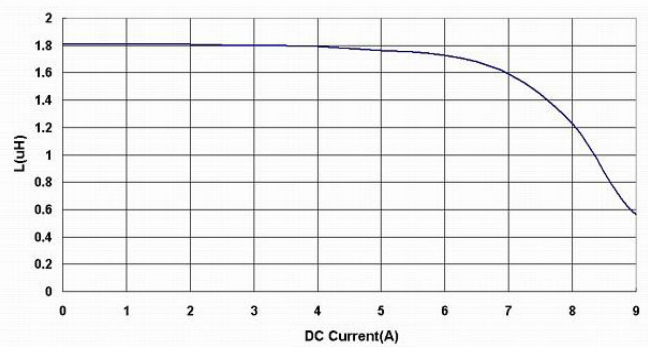

BPSD00060530 Series Specification

13 Graph:

BPSD000605302R0□00

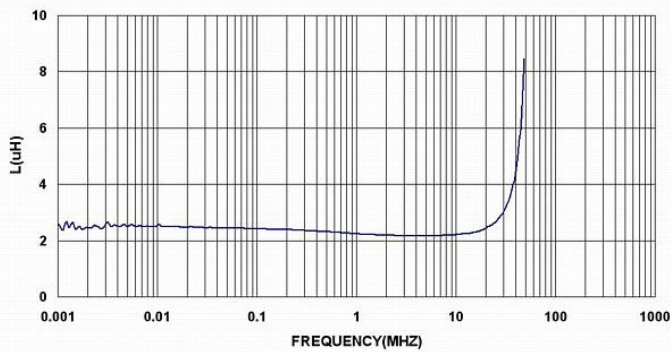
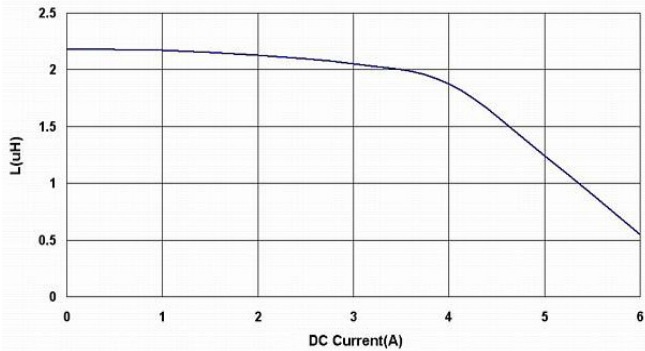

BPSD000605302R2□00

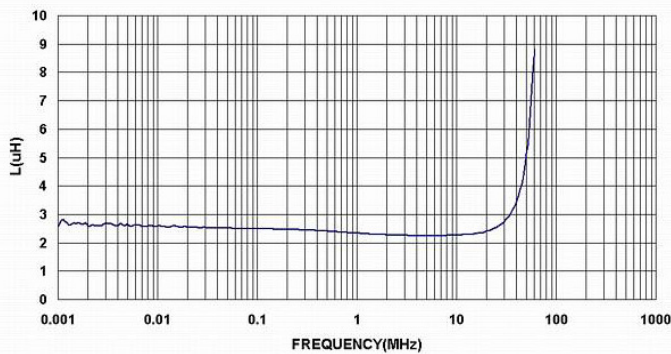
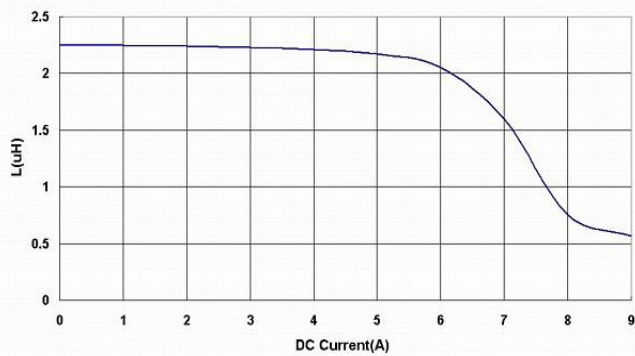

BPSD000605302R7□00

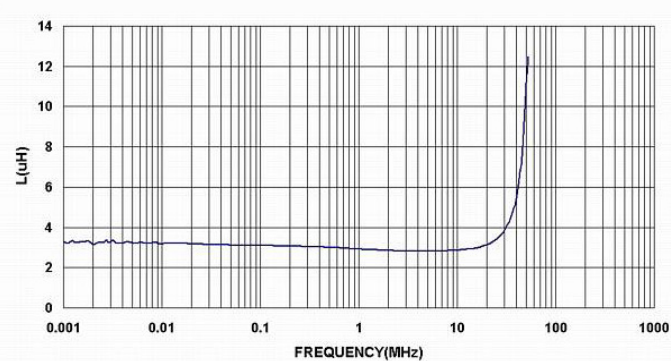

BPSD000605303R3□00

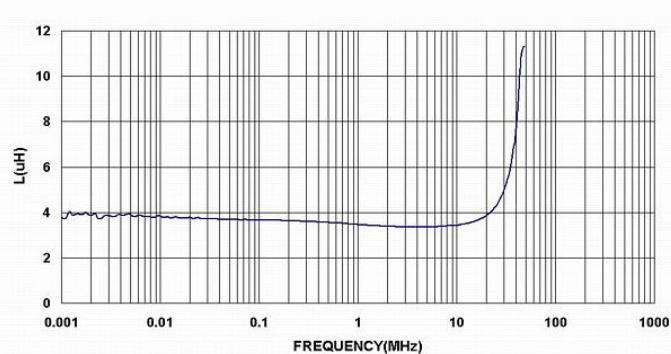
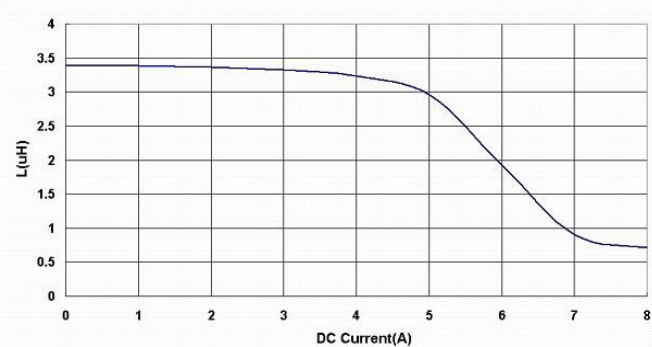

BPSD00060530 Series Specification

13 Graph:

BPSD000605303R9□00

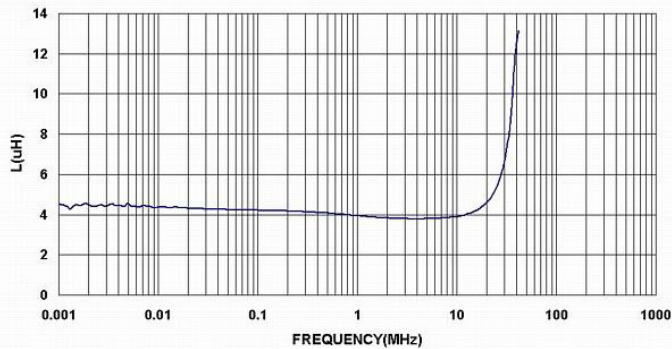

BPSD000605304R7□00

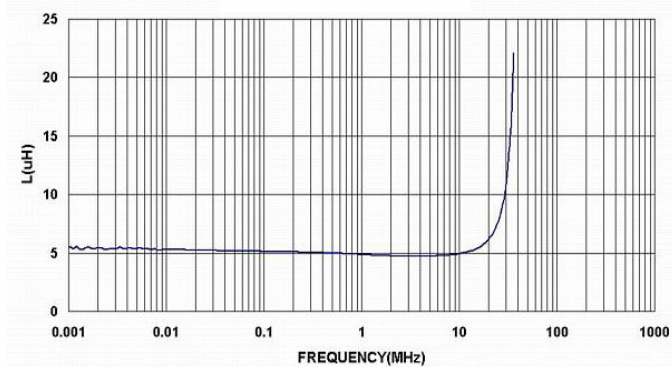
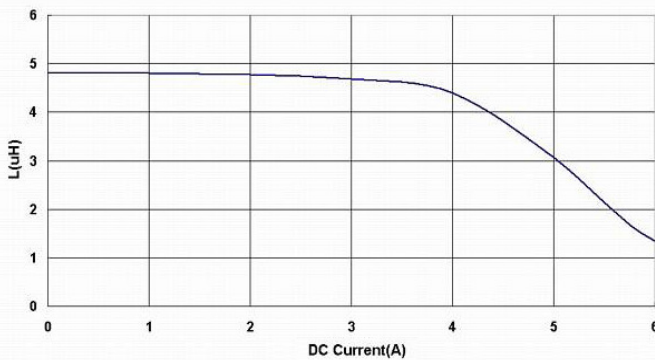

BPSD000605305R6□00

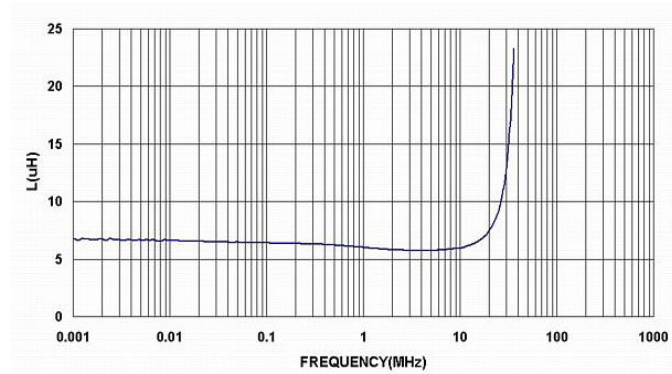
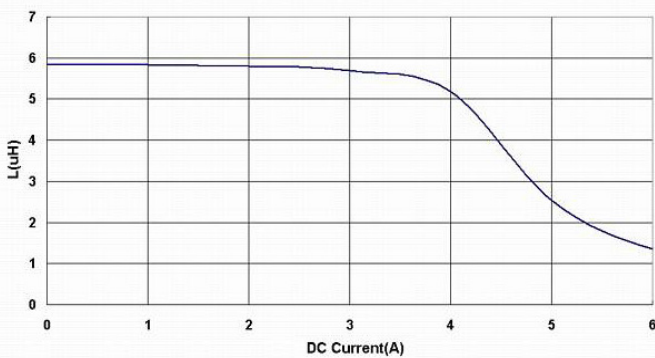

BPSD000605306R8□00

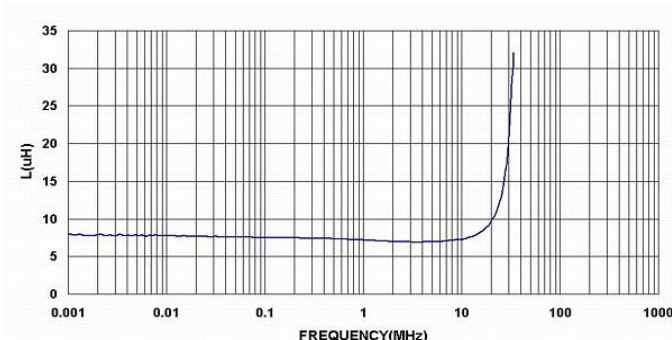
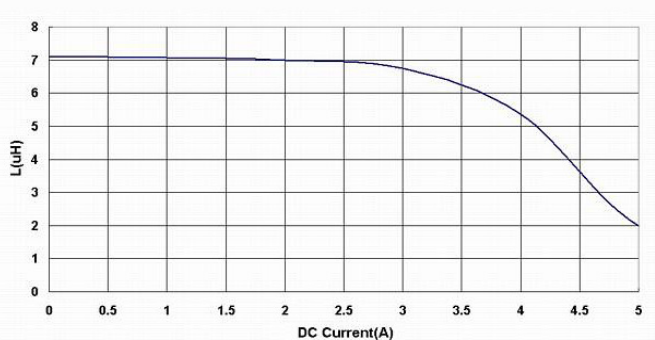

BPSD00060530 Series Specification

13 Graph:

BPSD000605308R2□00

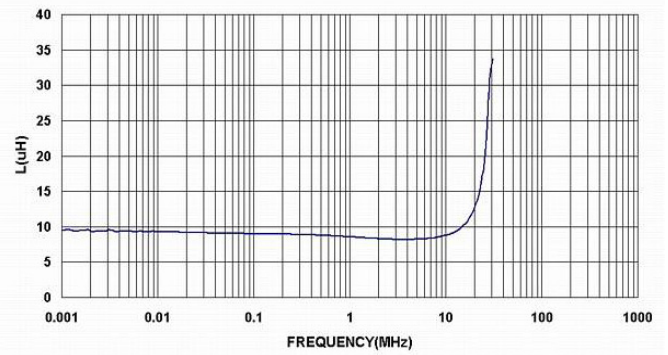
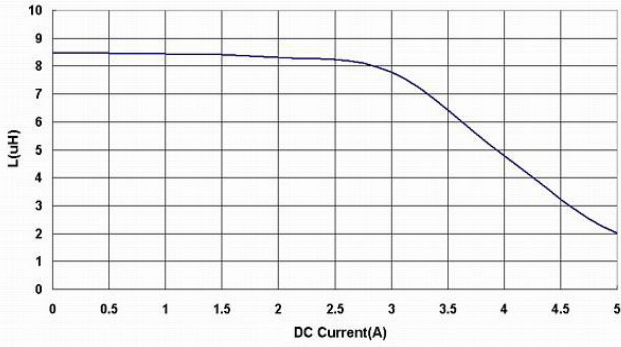

BPSD00060530100□00

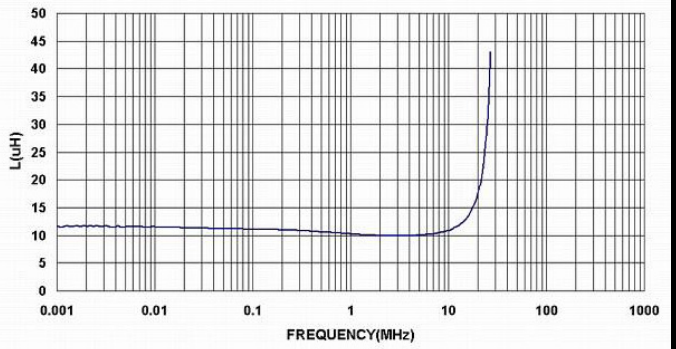
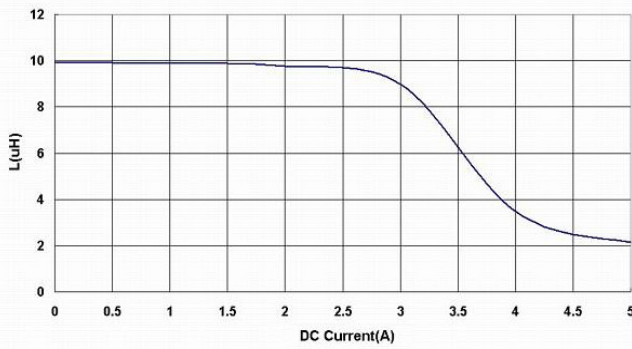

BPSD00060530120□00

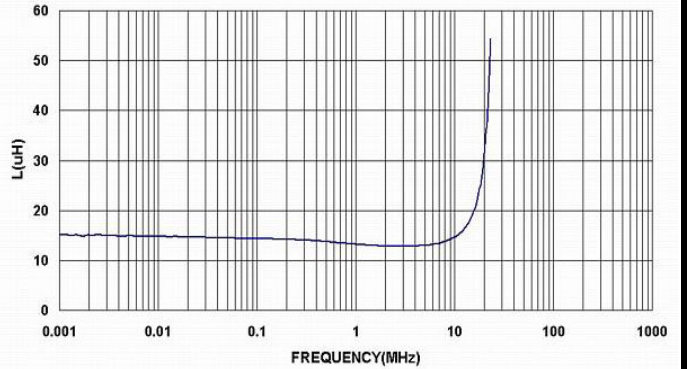
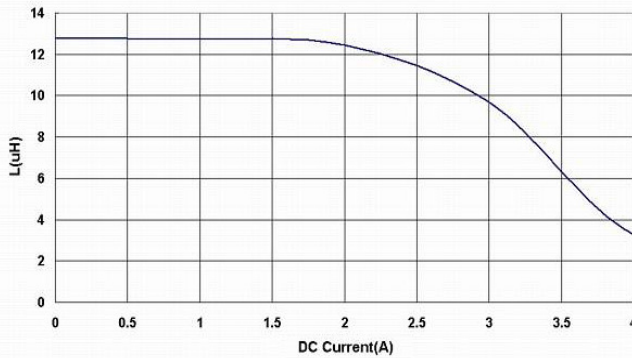

BPSD00060530150□00

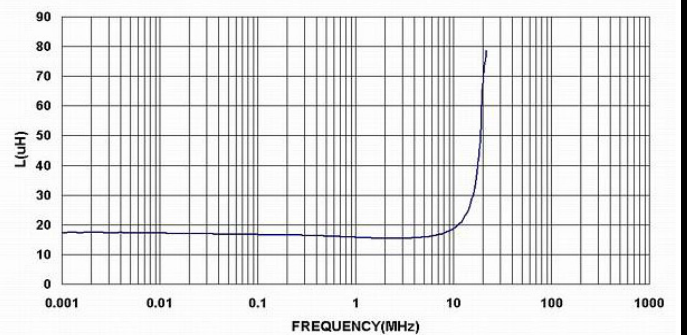
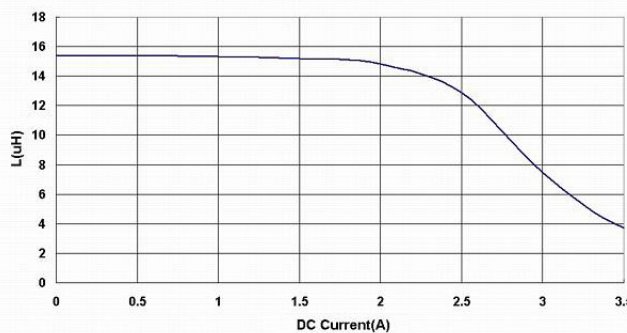

BPSD00060530 Series Specification

13 Graph:

BPSD00060530180□00

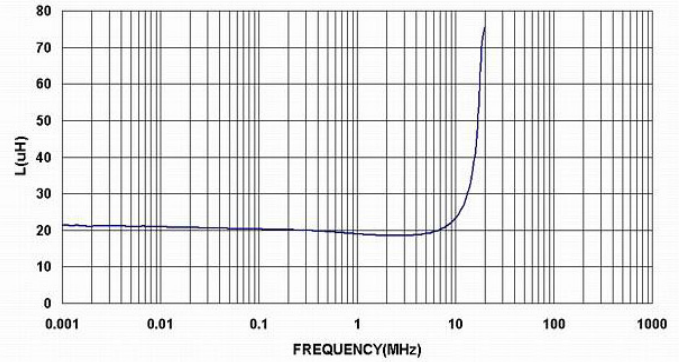
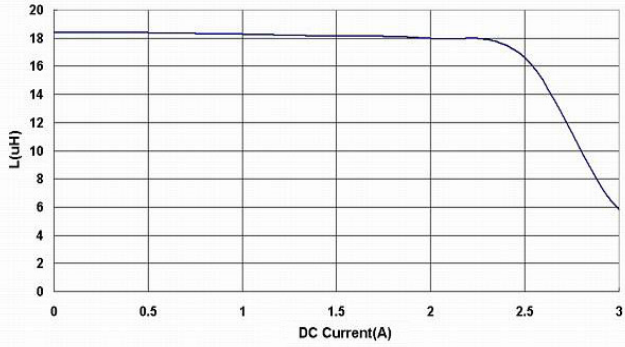

BPSD00060530220□00

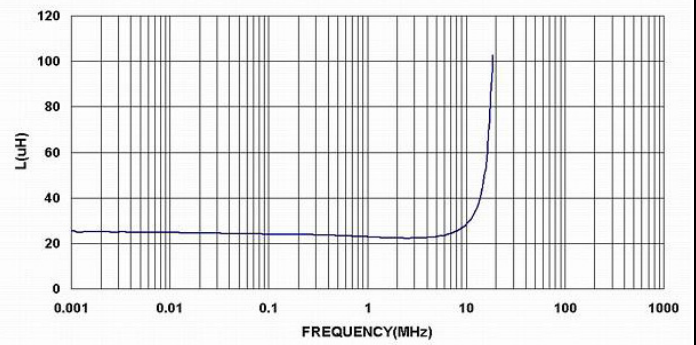
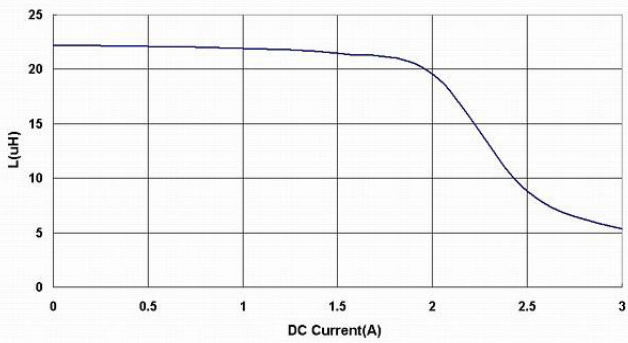

BPSD00060530270□00

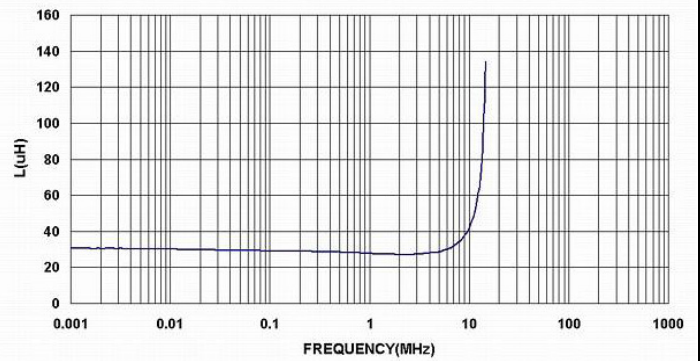
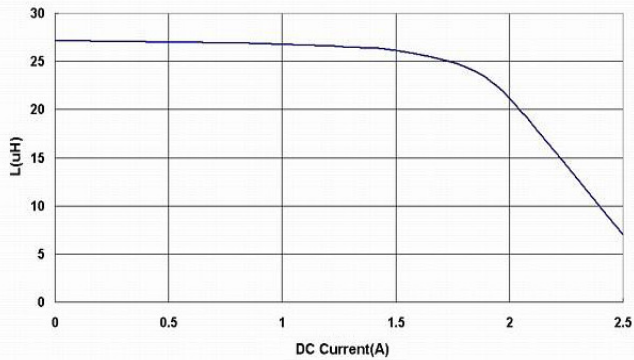

BPSD00060530330□00

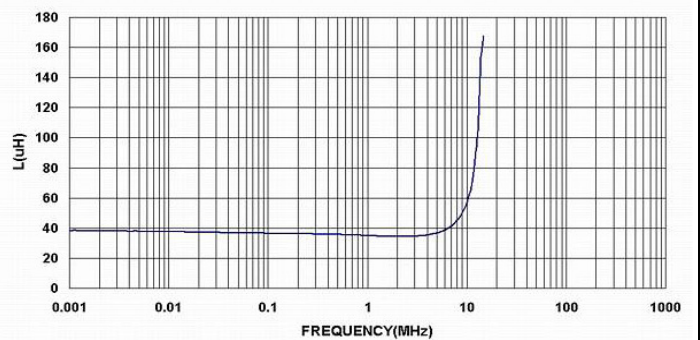
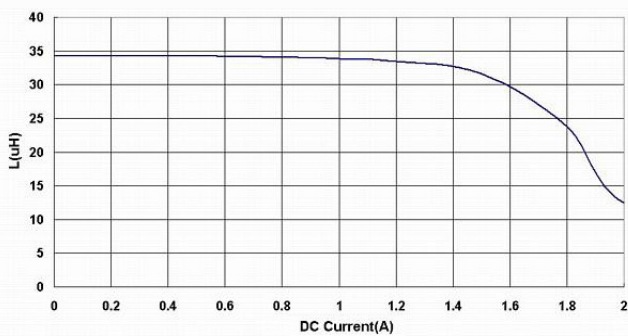

BPSD00060530 Series Specification

13 Graph:

BPSD00060530390□00

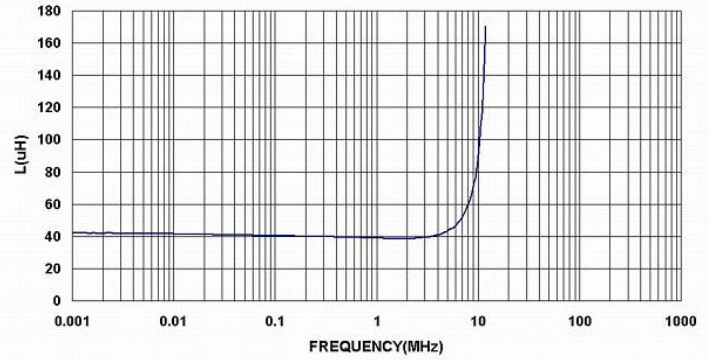
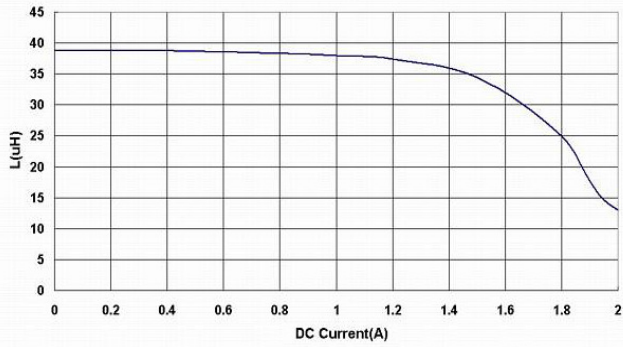

BPSD00060530470□00

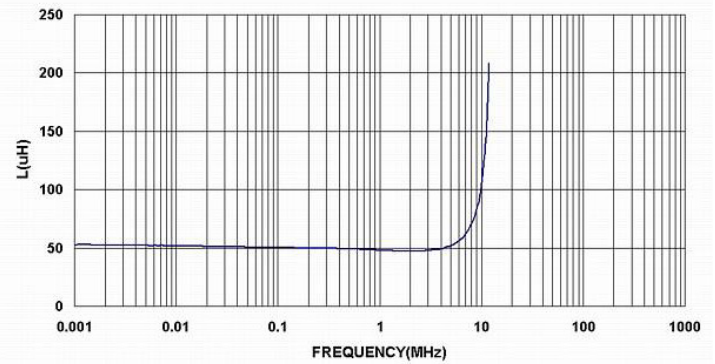
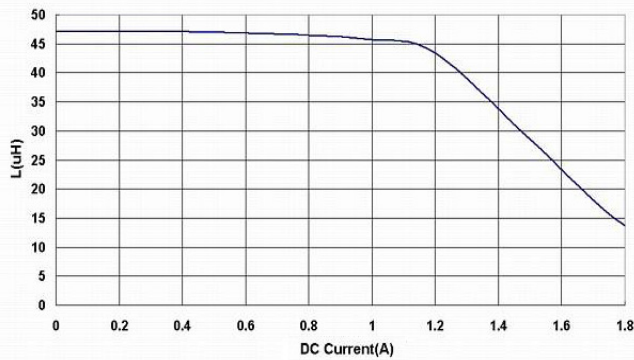

BPSD00060530560□00

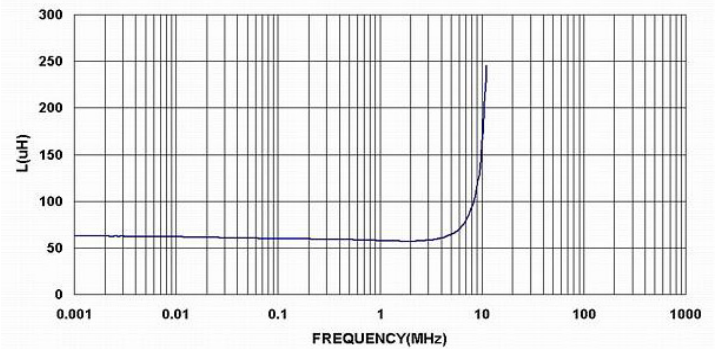
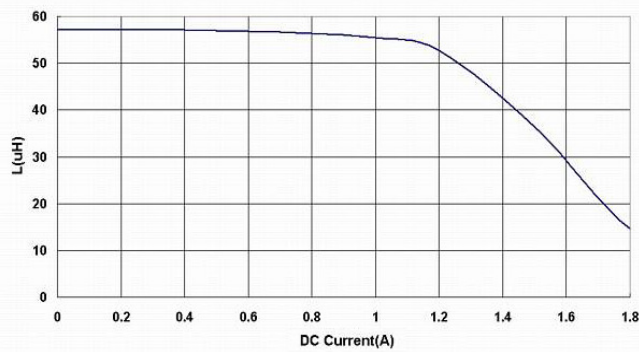

BPSD00060530680□00

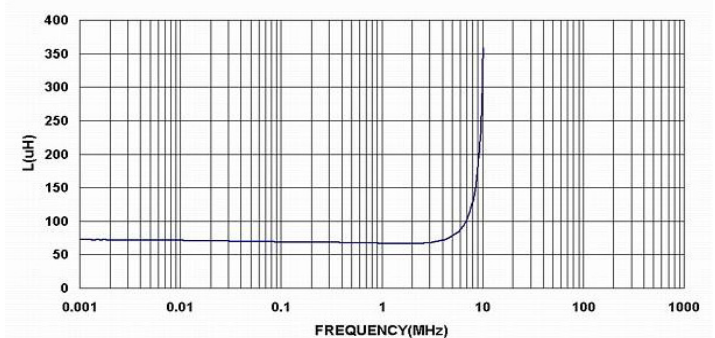
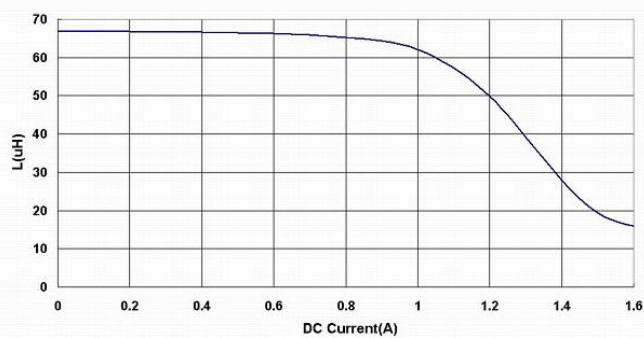

BPSD00060530 Series Specification

13 Graph:

BPSD00060530820□00

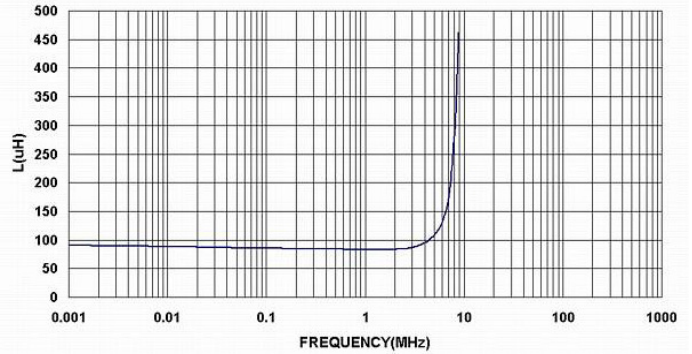
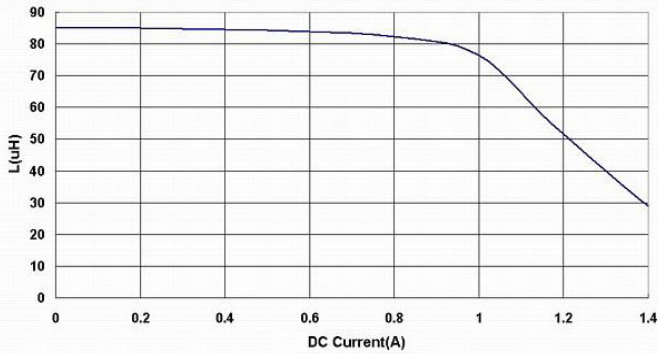

BPSD00060530101□00

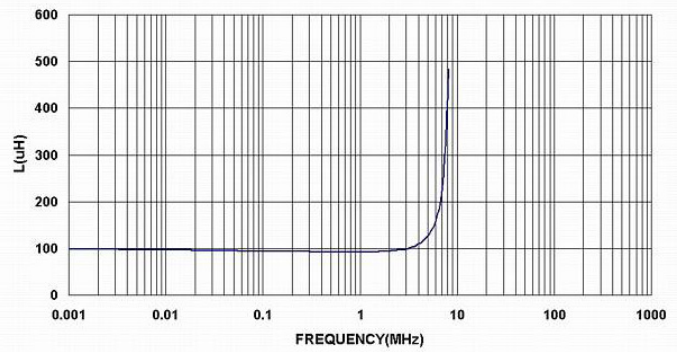
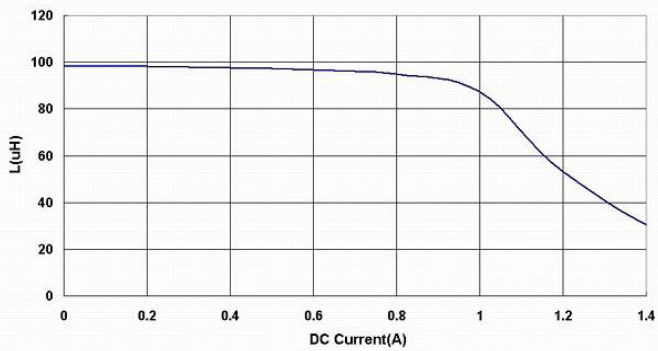

BPSD00060530121□00

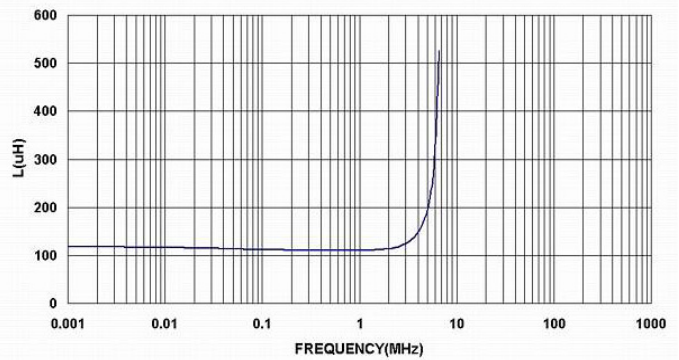
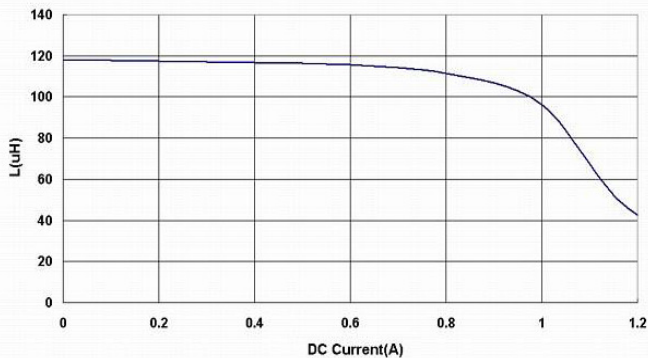

BPSD00060530151□00

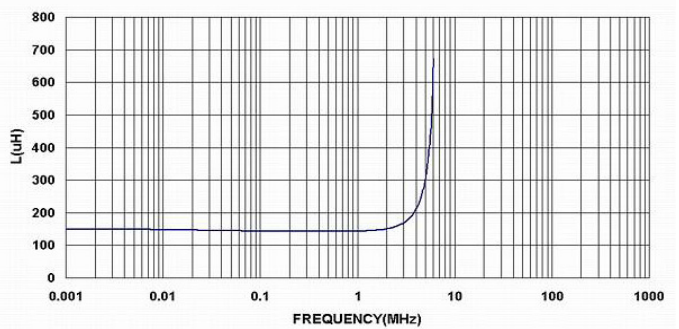
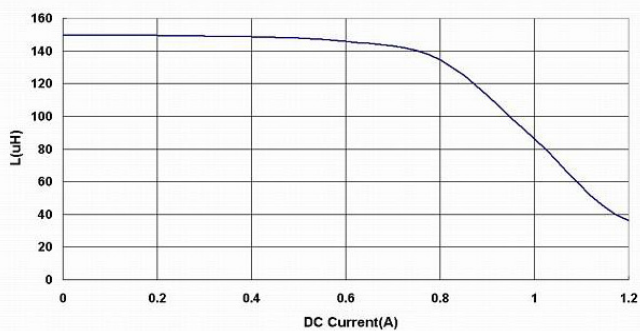

BPSD00060530 Series Specification

13 Graph:

BPSD00060530181□00

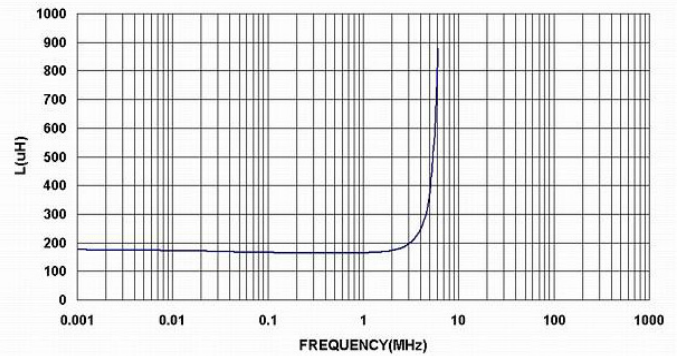
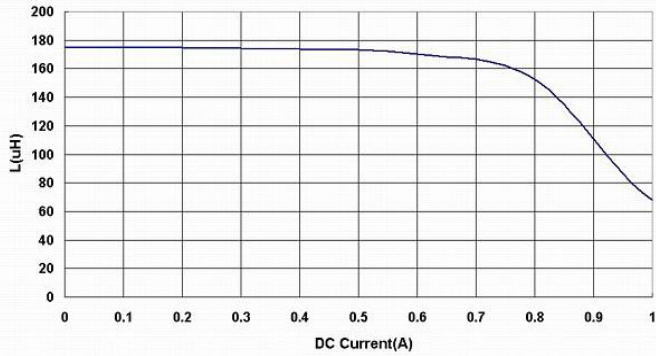

BPSD00060530221□00

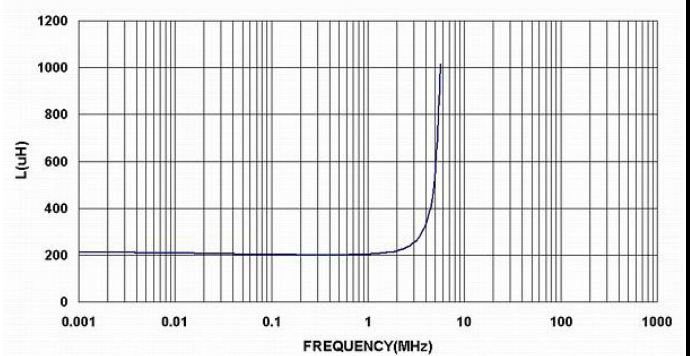
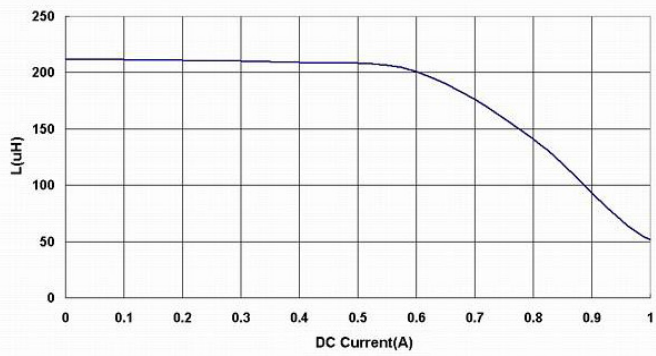

BPSD00060530271□00

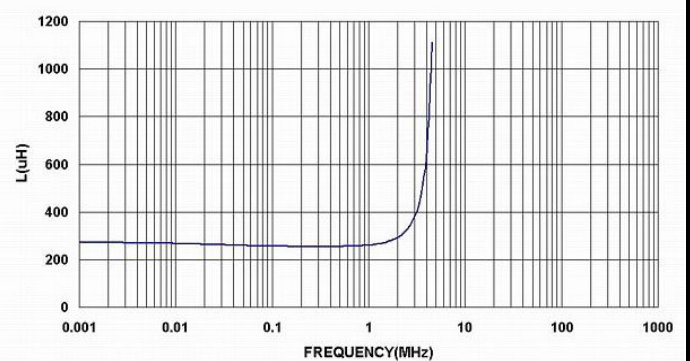
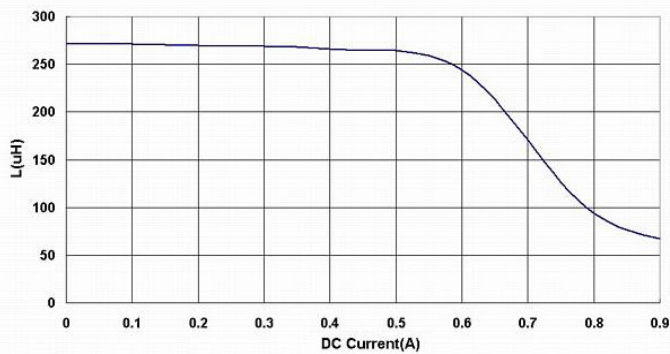

BPSD00060530331□00

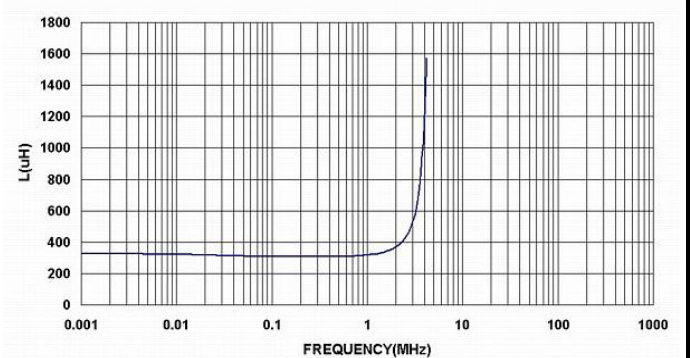
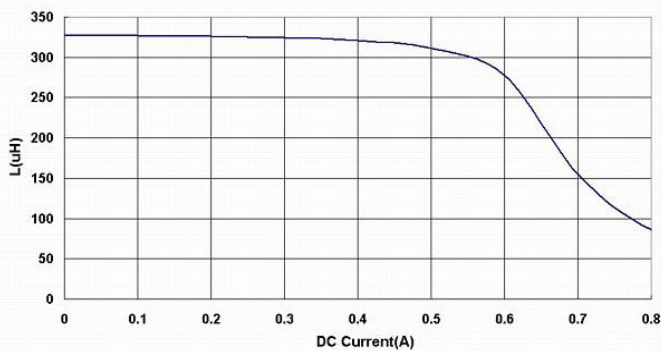

BPSD00060530 Series Specification

13 Graph:

BPSD00060530391□00

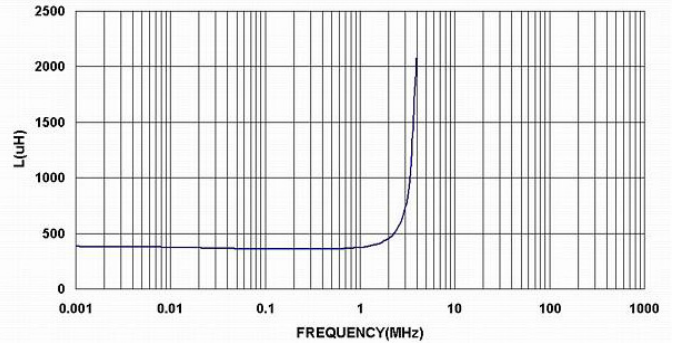
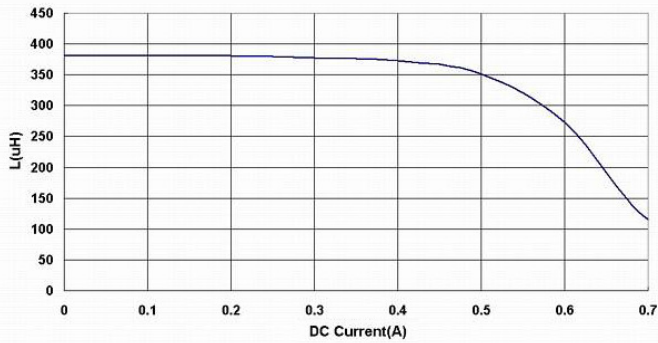

BPSD00060530471□00

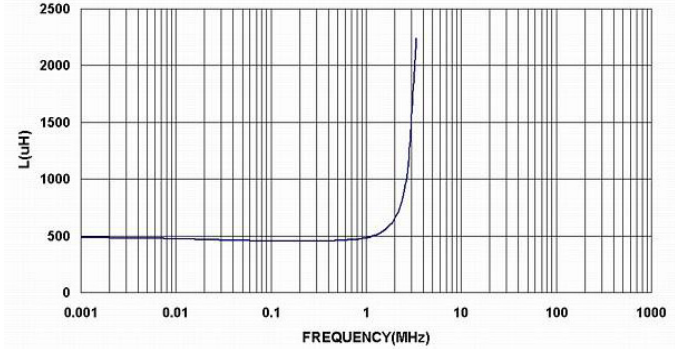
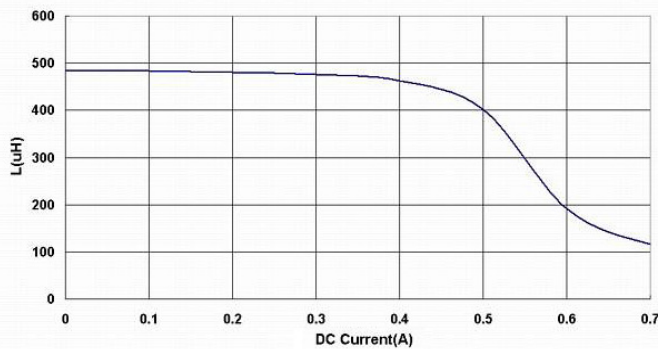

BPSD00060530561□00

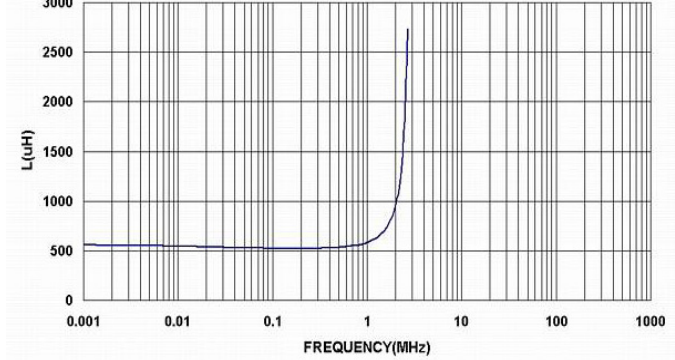
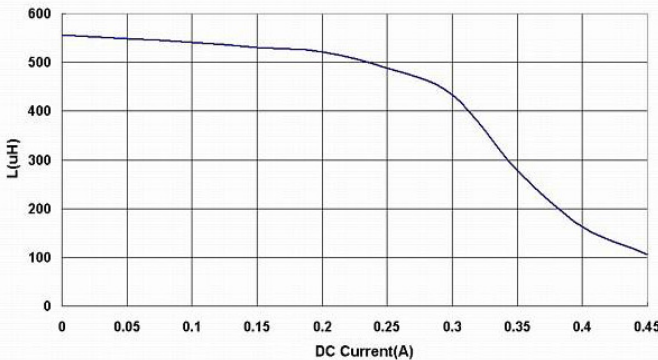

BPSD00060530681□00

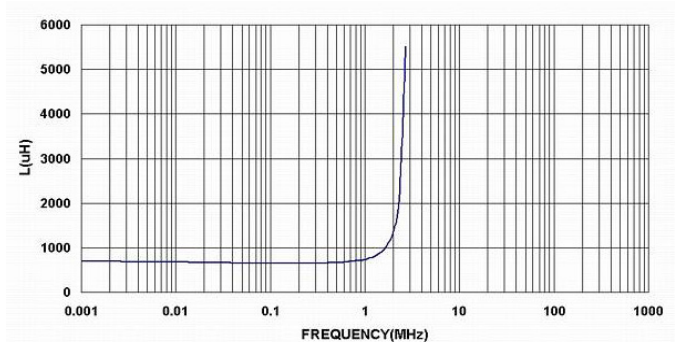
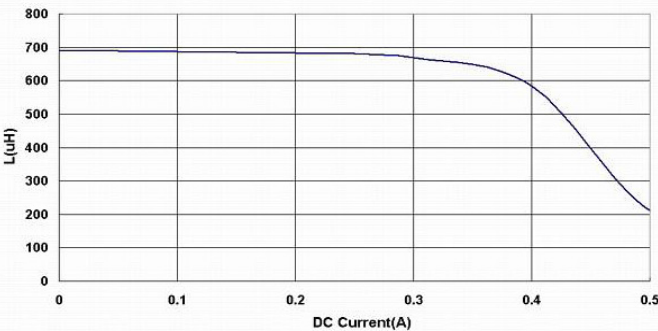

BPSD00060530 Series Specification

13 Graph:

BPSD00060530821□00

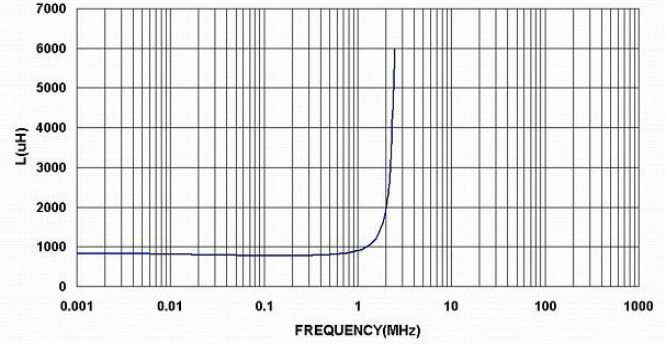
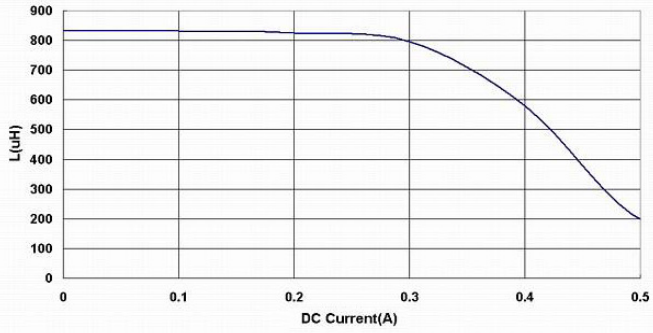

BPSD00060530102□00

