

SU10VFC-R10045

Aliases (UALSU10VR10045)

Common Mode Chokes - Power, KEMET, SU-10VFC-R, Through-Hole Bobbin, Common Mode, 4,500 uH

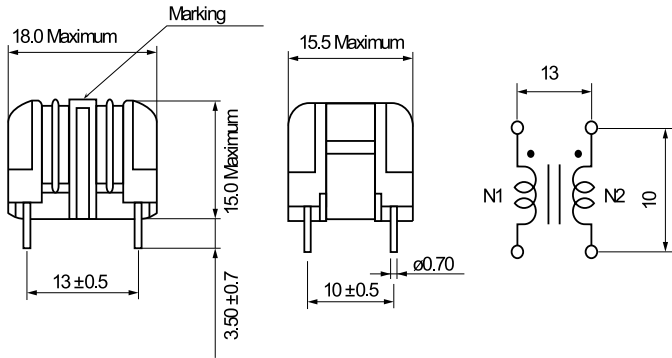

Click [here](#) for the 3D model.

General Information

Series	SU-10VFC-R
Style	Through-Hole Bobbin
RoHS	Yes
Miscellaneous	Temperature Rise Maximum: 50 K.
Core	Mn-Zn Ferrite

Specifications

Voltage AC	250 VAC
Inductance	4500 uH
Rated Current	1 A
Temperature Range	-40/+120°C
DC Resistance	0.55 Ohms

Dimensions

L	18mm MAX
T	15.5mm MAX
H	15mm MAX
LL	3.5mm +/-0.7mm
S	13mm +/-0.5mm
S1	10mm +/-0.5mm
Wire Size	0.3mm
F	0.7mm NOM

Packaging Specifications

Packaging	Tray
Packaging Quantity	700
Typical Component Weight	6.4 g

Statements of suitability for certain applications are based on our knowledge of typical operating conditions for such applications, but are not intended to constitute - and we specifically disclaim - any warranty concerning suitability for a specific customer application or use. This Information is intended for use only by customers who have the requisite experience and capability to determine the correct products for their application. Any technical advice inferred from this Information or otherwise provided by us with reference to the use of our products is given gratis, and we assume no obligation or liability for the advice given or results obtained.