

## SSR21NH-07405

Aliases (UALN21H0740500)

Common Mode Chokes - Power, KEMET, SSR21NV/NH, Through-Hole Bobbin, Common Mode, 0.0405 H

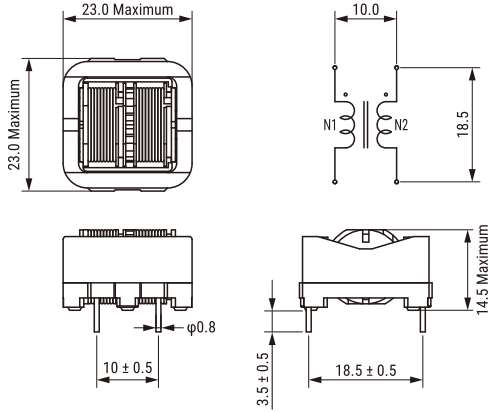

Click [here](#) for the 3D model.

### General Information

Series	SSR21NV/NH
Style	Through-Hole Bobbin
Features	Compact Size, Light Weight, High Performance, Low DCR, High Impedance, Strong Inductance
RoHS	Yes
Miscellaneous	45 (K) Temperature Rise Max.
Core	Mn-Zn Ferrite

### Dimensions

L	23mm MAX
T	23mm MAX
H	14.5mm MAX
LL	3.5mm +/-0.5mm
S	10mm +/-0.5mm
S1	18.5mm +/-0.5mm
Wire Size	0.3mm
F	0.8mm NOM

### Packaging Specifications

Packaging	Tray
Packaging Quantity	420
Typical Component Weight	13 g

### Specifications

Voltage AC	250 VAC
Inductance	40.5 mH
Rated Current	700 mA
Temperature Range	-40/+120°C
DC Resistance	0.61 Ohms

Statements of suitability for certain applications are based on our knowledge of typical operating conditions for such applications, but are not intended to constitute - and we specifically disclaim - any warranty concerning suitability for a specific customer application or use. This Information is intended for use only by customers who have the requisite experience and capability to determine the correct products for their application. Any technical advice inferred from this Information or otherwise provided by us with reference to the use of our products is given gratis, and we assume no obligation or liability for the advice given or results obtained.