

SSR10HS-22026

Aliases (UALR10HS220260)

Common Mode Chokes - Power, KEMET, SSR10VS/HS, Through-Hole Bobbin, Common Mode, 2,600 uH

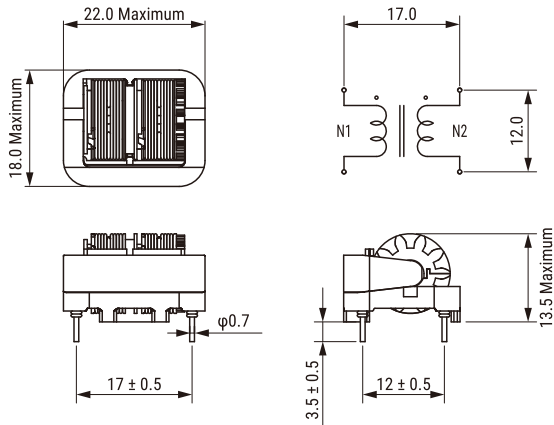

Click [here](#) for the 3D model.

General Information

Series	SSR10VS/HS
Style	Through-Hole Bobbin
Features	Compact Size, Low Profile, Light Weight, High Frequency, Broad Bandwidth
RoHS	Yes
Miscellaneous	55 (K) Temperature Rise Max.
Core	Mn-Zn Ferrite

Dimensions

L	22mm MAX
T	18mm MAX
H	13.5mm MAX
LL	3.5mm +/-0.5mm
S	17mm +/-0.5mm
S1	12mm +/-0.5mm
Wire Size	0.45mm
F	0.7mm NOM

Packaging Specifications

Packaging	Tray
Packaging Quantity	300
Typical Component Weight	9 g

Specifications

Voltage AC	250 VAC
Inductance	2.6 mH
Rated Current	2.2 A
Temperature Range	-25/+120°C
DC Resistance	0.1 Ohms

Statements of suitability for certain applications are based on our knowledge of typical operating conditions for such applications, but are not intended to constitute - and we specifically disclaim - any warranty concerning suitability for a specific customer application or use. This Information is intended for use only by customers who have the requisite experience and capability to determine the correct products for their application. Any technical advice inferred from this Information or otherwise provided by us with reference to the use of our products is given gratis, and we assume no obligation or liability for the advice given or results obtained.