

SBT-0210

Aliases (UDLSBT00210000)
Differential Mode Chokes - Signal, KEMET, SBT, Through-Hole, Normal Mode, 10 uH, 50%

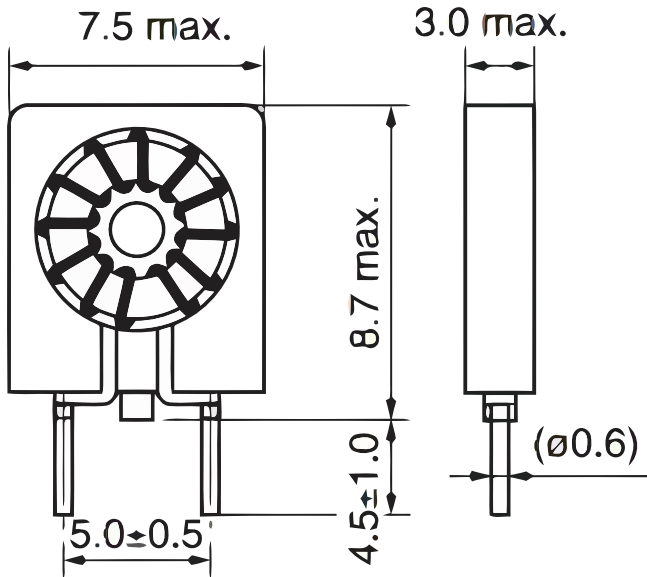

Click [here](#) for the 3D model.

General Information

Series	SBT
Style	Through-Hole
RoHS	Yes
Miscellaneous	Inductance: 70mAmps (1kHz).

Dimensions

L	7.5mm MAX
W	3mm MAX
T	3mm MAX
H	8.7mm MAX
LL	4.5mm +/-1mm
S	5mm +/-0.5mm
F	0.6mm NOM

Packaging Specifications

Packaging	Bulk
Packaging Quantity	100
Typical Component Weight	240 mg

Specifications

Voltage DC	50 VDC
Inductance	10 uH
Inductance Tolerance	50%
Temperature Range	-25/+70°C
DC Resistance	20 mOhms (per Line MAX)

Statements of suitability for certain applications are based on our knowledge of typical operating conditions for such applications, but are not intended to constitute - and we specifically disclaim - any warranty concerning suitability for a specific customer application or use. This Information is intended for use only by customers who have the requisite experience and capability to determine the correct products for their application. Any technical advice inferred from this Information or otherwise provided by us with reference to the use of our products is given gratis, and we assume no obligation or liability for the advice given or results obtained.