

## FLLE2016AUBD

Aliases (LLE2016AUBD)

Obsolete

EMI Filters, KEMET, FLLE2-U, Chassis Mount, Noise Suppression, 4,000 uH, 130.5x56.5x48.5mm

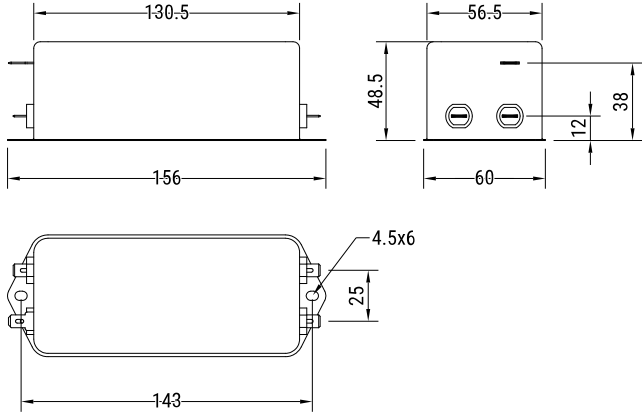

Click [here](#) for the 3D model.

### General Information

Series	FLLE2-U
Style	Chassis Mount
Description	Single Phase, Chassis Mount Filters
Features	Single Phase
Phase	Single-phase
RoHS	Yes
Qualifications	IEC/EN 60939, UL, CSA
Lead	Fast On
Terminal Type	Faston
Test Voltage DC (P to N)	1300 VDC

### Dimensions

L	130.5mm MIN
W	56.5mm MIN
H	48.5mm MIN
Lead	Fast On

### Packaging Specifications

Packaging	Bulk
Packaging Quantity	1
Typical Component Weight	700 g

### Specifications

Voltage AC	300 VAC
Voltage DC	300 VDC
Inductance	4 mH
Rated Frequency	50-60 Hz
Rated Current	16 A
Ripple Current	16 A
Rated Temperature	40°C
Temperature Range	-25/+100°C
Climate Category	25/100/21
Leakage Current	0.86 mA
Test Voltage DC (P/N to E)	2250 VDC

Statements of suitability for certain applications are based on our knowledge of typical operating conditions for such applications, but are not intended to constitute - and we specifically disclaim - any warranty concerning suitability for a specific customer application or use. This Information is intended for use only by customers who have the requisite experience and capability to determine the correct products for their application. Any technical advice inferred from this Information or otherwise provided by us with reference to the use of our products is given gratis, and we assume no obligation or liability for the advice given or results obtained.