

## CCR06CG682GR

Aliases (C062G682G5G5CR)

LDD Mil COG PRF20, Ceramic, 6,800 pF, 2%, 50 VDC, COG, R (0.01%/1000 Hrs), 5.08 mm

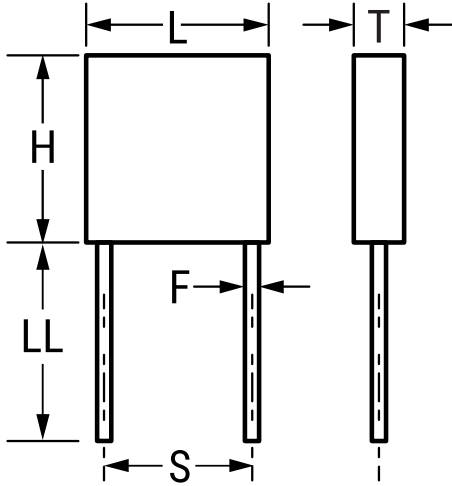

Click [here](#) for the 3D model.

### General Information

Series	LDD Mil COG PRF20
Style	Radial
RoHS	No
Prop 65	<b>WARNING:</b> Cancer and reproductive harm - <a href="https://www.p65warnings.ca.gov/">https://www.p65warnings.ca.gov/</a>
SCIP Number	8c864fd1-202b-4ce7-85fd-56c9e19121ad
Termination	Lead (SnPb)
Lead	Wire Leads
Failure Rate	R (0.01%/1000 Hrs)
Testing and Reliability	MIL-PRF-20
Qualifications	MIL-PRF-20
Notes	Lead Length Shown Is For Parts Supplied In Bulk, See Packaging Specifications For Lead Lengths When Not Provided In Bulk.

### Dimensions

L	7.37mm +/-0.25mm
H	7.37mm +/-0.25mm
T	2.29mm +/-0.25mm
S	5.08mm +/-0.38mm
LL	31.75mm MIN
F	0.64mm +0.102/-0.051mm

### Packaging Specifications

Packaging	Bulk, Bag
Packaging Quantity	100

### Specifications

Capacitance	6,800 pF
Tolerance	2%
Voltage DC	50 VDC
Dielectric Withstanding Voltage	125 VDC
Temperature Range	-55/+125°C
Temp. Coefficient	COG
Dissipation Factor	0.15%
Insulation Resistance	100 GOhms

Statements of suitability for certain applications are based on our knowledge of typical operating conditions for such applications, but are not intended to constitute - and we specifically disclaim - any warranty concerning suitability for a specific customer application or use. This Information is intended for use only by customers who have the requisite experience and capability to determine the correct products for their application. Any technical advice inferred from this Information or otherwise provided by us with reference to the use of our products is given gratis, and we assume no obligation or liability for the advice given or results obtained.