

ALC70E332FP350

ALC70, Aluminum, Aluminum Electrolytic, 3,300 uF, 20%, 350 VDC, -40/+85°C, 22.5 mm

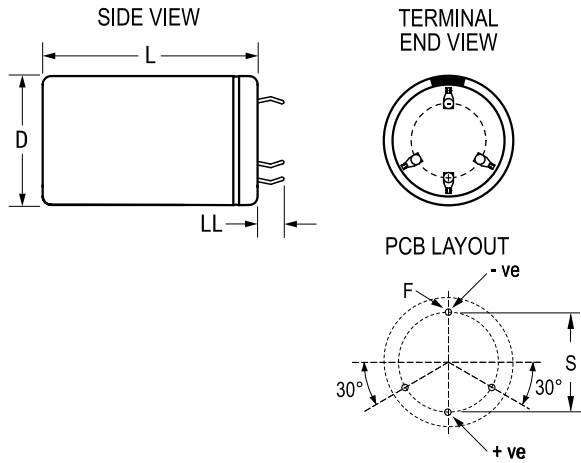

Click [here](#) for the 3D model.

General Information

Series	ALC70
Dielectric	Aluminum Electrolytic
Description	Snap-In, Aluminum Electrolytic
RoHS	Yes
Lead	4 Pin Short
Halogen Free	Yes
Typical Component Weight	225 g
Notes	Dimensions D And L Include Sleaving.
Shelf Life	156 Weeks

Dimensions

D	45mm +1mm
L	105mm +/-2mm
S	22.5mm +/-0.1mm
LL	4mm +/-1mm
F	2mm +/-0.1mm

Packaging Specifications

Sleaving	Yes
Packaging	Bulk, Bag

Specifications

Capacitance	3,300 uF
Tolerance	20%
Voltage DC	350 VDC, 385 VDC (Surge)
Temperature Range	-40/+85°C
Rated Temperature	85°C
Life	18000 Hrs (Rated Voltage And Ripple Current At 85C), 29000 Hrs (Rated Voltage At 85C)
ESR	46.6 mOhms (100Hz 20C), 25.65 mOhms (10kHz 20C)
Ripple Current	8.138 Amps (100Hz 85C), 15.8 Amps (10kHz 85C)
Leakage Current	6000 uA (5min 20°C)

Statements of suitability for certain applications are based on our knowledge of typical operating conditions for such applications, but are not intended to constitute - and we specifically disclaim - any warranty concerning suitability for a specific customer application or use. This Information is intended for use only by customers who have the requisite experience and capability to determine the correct products for their application. Any technical advice inferred from this Information or otherwise provided by us with reference to the use of our products is given gratis, and we assume no obligation or liability for the advice given or results obtained.