

A72SQ2100AA00K

Aliases (72SQ2100AA00K)

Obsolete

A72, Film, Film/Foil Polypropylene, General Purpose, 0.01 uF, 10%, 1,500 VDC, 450 VAC, 85°C

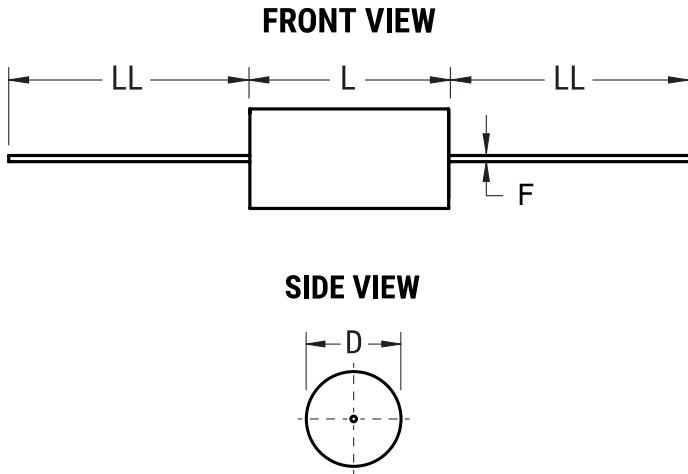

Click [here](#) for the 3D model.

General Information

Series	A72
Dielectric	Film/Foil Polypropylene
Style	Axial
RoHS	Yes
Lead	Wire Leads
Typical Component Weight	2.6 g
Miscellaneous	Above 85C DC And AC Voltage Derating Is 1.25%/C. maxKO = 18000000.

Dimensions	
D	9.5mm MAX
L	28mm MAX
LL	40mm +/-5mm
F	0.8mm +/-0.05mm

Packaging Specifications	
Packaging	Bulk, Bag
Packaging Quantity	500

Specifications	
Capacitance	0.01 uF
Tolerance	10%
Voltage DC	1500 VDC, 1125 VDC (105C)
Voltage AC	450 VAC
Temperature Range	-55/+105°C
Rated Temperature	85°C
Dissipation Factor	0.05% 10kHz, 0.1% 100kHz
Insulation Resistance	100 GOhms
Max dV/dt	6,000 V/us
Inductance	28 nH

Statements of suitability for certain applications are based on our knowledge of typical operating conditions for such applications, but are not intended to constitute - and we specifically disclaim - any warranty concerning suitability for a specific customer application or use. This Information is intended for use only by customers who have the requisite experience and capability to determine the correct products for their application. Any technical advice inferred from this Information or otherwise provided by us with reference to the use of our products is given gratis, and we assume no obligation or liability for the advice given or results obtained.